



Theses and Dissertations

2006-12-09

Design Drawing in Instructional Design at Brigham Young University's Center for Instructional Design: A Case Study

S. Todd Stubbs

Brigham Young University - Provo

Follow this and additional works at: <https://scholarsarchive.byu.edu/etd>



Part of the [Educational Psychology Commons](#)

BYU ScholarsArchive Citation

Stubbs, S. Todd, "Design Drawing in Instructional Design at Brigham Young University's Center for Instructional Design: A Case Study" (2006). *Theses and Dissertations*. 1117.

<https://scholarsarchive.byu.edu/etd/1117>

This Dissertation is brought to you for free and open access by BYU ScholarsArchive. It has been accepted for inclusion in Theses and Dissertations by an authorized administrator of BYU ScholarsArchive. For more information, please contact scholarsarchive@byu.edu, ellen_amatangelo@byu.edu.

DESIGN DRAWING IN INSTRUCTIONAL DESIGN AT BRIGHAM YOUNG UNIVERSITY'S

CENTER FOR INSTRUCTIONAL DESIGN:

A CASE STUDY

by

S. Todd Stubbs

A dissertation submitted to the faculty of

Brigham Young University

in partial fulfillment of the requirement for the degree of

Doctor of Philosophy

Department of Instructional Psychology and Technology

Brigham Young University

December 2006

Copyright © 2006 S. Todd Stubbs

All Rights Reserved

BRIGHAM YOUNG UNIVERSITY

GRADUATE COMMITTEE APPROVAL

of a dissertation submitted by

S. Todd Stubbs

This dissertation has been read by each member of the following graduate committee and by majority vote has been found to be satisfactory.

Date

Andrew S. Gibbons

Date

R. Brent Adams

Date

Larrie E. Gale

Date

Charles R. Graham

Date

David D. Williams

BRIGHAM YOUNG UNIVERSITY

As chair of the candidate's graduate committee, I have read the dissertation of S. Todd Stubbs in its final form and have found that (1) its format, citations, and bibliographic style are consistent and acceptable and fulfill university and department style requirements; (2) its illustrative materials including figures, tables, and charts are in place; and (3) the final manuscript is satisfactory to the graduate committee and is ready for submission to the university library

Date

Andrew S. Gibbons
Chair, Graduate Committee

Accepted for the Department

Andrew S. Gibbons
Department Chair

Accepted for the College

K. Richard Young
Dean, David O. McKay School of Education

ABSTRACT

DESIGN DRAWING IN INSTRUCTIONAL DESIGN AT BRIGHAM YOUNG UNIVERSITY'S
CENTER FOR INSTRUCTIONAL DESIGN:
A CASE STUDY

S. Todd Stubbs

Instructional Psychology & Technology Department

Doctor of Philosophy

The purpose of this study is to compare the use of design drawing in design fields such as architecture, engineering, and industrial design with its use in instructional design (ID). This study was conducted in three parts: first, a review of literature to understand the role and value design drawing plays in non-ID fields; second, a search for design drawing in the literature of ID; and third, observations of actual use of design drawing in ID in the field.

For the first part, the literature of design studies was reviewed regarding design drawing. For the second part, the literature review includes a search for evidence of design drawing in ID. The literature of design drawing in design studies was rich and varied; the literature of ID showed comparatively little interest in design drawing.

For the third part of this study, ID design meetings at Brigham Young University's Center for Instructional Design (CID) were observed using a qualitative, naturalistic approach. These observations were supplemented with interviews of instructional designers. The evidence gathered was analyzed in light of the literature review to better understand design drawing in ID. Three case studies were assembled from these observations and analyses on the use of design drawing at CID.

This study concludes that design drawing plays an important and prominent role in ID, fulfilling many of the same roles and providing many of the same advantages it does in other design fields. However, design drawing in ID employed a very limited repertoire of forms, and was used to represent a limited number of design purposes. Design drawing in ID lacked the proficiency, the high level of self-awareness, and the sophistication of the design drawing described in the literature of design studies.

Based on these conclusions, it is recommended that instructional designers need to develop a design drawing tradition and standards that might potentially expand the ability of instructional designs to improve over time, as well as their creativity.

ACKNOWLEDGEMENTS

I have often read in other dissertations the gratitude that the writers have for spouses, children, parents, and colleagues, and thought, “This is merely kind hyperbole, written to show gratitude and humility.” Now, having gone through the experience myself, I understand the debt of gratitude I owe to those without whom, it could not have happened.

I owe a most profound debt of gratitude to my wife, Joy, who stood by me with cheerfulness and patience while I slogged along. Because she was always encouraging, never doubting or resentful of the time and energy spent (at least not visibly), a large portion of credit for finishing this dissertation is due to her love and support. I love you, Joy! I’m also grateful for my children for standing by me during this endeavor. “I need to work on my dissertation” has become a catch phrase meaning, “Not now” which they have endured with grace—especially Abby. Thank you.

Second, without the patient guidance of Dr. Andy Gibbons, this work would not have happened, and I would not have been able to make it happen. The hours (months!) spent working with him are among my choicest memories of graduate school. I have learned so much! I am also grateful for the assistance, support, and ideas of other faculty at BYU with whom I’ve worked, particularly those of my committee.

Third, I would like to acknowledge my colleagues at the Center for Instructional Design, who been encouraging and understanding while I completed this dissertation. I am particularly grateful to CID director Dr. Jon Mott, and my former supervisor, Dr. Greg Waddoups for their support and patience. Thank you!

Because of this work, my efforts to serve in my calling have been attenuated. My brethren in that calling have supported me in countless ways, filling in gaps, and taking over when I was unavailable. They did this without complaint, and I'm grateful both for their efforts and their great examples of Christ-like love. Thank you, Don Pectol and Bishop Kevan Allbee for your support.

For my parents, Stanford and Marilyn Stubbs, thank you. How I would like for you to have seen this, Dad!

Perhaps the greatest quiet influence of this work, and indeed of my life, is my Heavenly Father who has never failed me, though I have often failed Him. How grateful I am for a loving Heavenly Father who has given me strength in every time of need. How blessed I am!

CONTENTS

CONTENTS	ix
LIST OF TABLES.....	xi
LIST OF FIGURES.....	xii
CHAPTER 1—INTRODUCTION.....	1
Statement of the Problem & Significance of the Study	4
Assumptions.....	5
Definition of Terms.....	6
Organization of the Study	7
Purpose of the Study.....	8
Research Question	8
CHAPTER 2—LITERATURE REVIEW	9
Definitions	10
Design.....	10
Drawing, Sketching & Other Terms	12
Design Drawing and Design Sketching.....	14
Research in Design Drawing	14
The Importance of Representations & Models to Design.....	15
Examples of Representations & Models	16
Design Drawing is an Essential Part of Design.....	30
Summary of Research on Design Drawing in Design Studies.....	53
Evidences of Design Drawing in ID.....	54
A Typology of Images	54
Extending the Typology of Type 1 Design Graphics with ID Layers.....	61
ID Literature Sampling	62
Results of ID Literature Review	67
Summary Design Drawing in ID.....	85

Chapter Summary.....	85
CHAPTER 3—METHODOLOGY	87
Philosophical Underpinnings	87
Exploration-type of Research—Gibbons & Bunderson	87
Methods Used in General Design Studies—Craig, Cross, & Others.....	88
Guiding Principles—Stake, Eisner, & Dervin.....	90
Study Procedures	92
Selection of the Case	92
Data Collection Process.....	94
Analysis Procedures	99
Assuring Trustworthiness, Research Standards.....	101
CHAPTER 4—RESULTS	104
Case One: Steven & Tammy.....	104
Case Two: Natalie & Kyle.....	115
Case Three: Nathan & Larry.....	123
Conclusion.....	131
CHAPTER 5—DISCUSSION & CONCLUSIONS.....	132
Design Drawing in ID and in Other Design Fields	133
Themes from the literature review	133
Observations unanticipated from the literature review.....	142
Summary of Findings.....	144
Limitations	145
Recommendations for Future Research.....	146
REFERENCES	153

LIST OF TABLES

Table 2.1. Types of graphics found in three ID textbooks.....	68
Table 2.2. Types of graphics found in three ID journals.....	70

LIST OF FIGURES

Figure 2.1. Thumbnail sketches of assorted advertisements found in Time magazine.	17
Figure 2.2. Progression from a bubble diagram (A) to architectural plan (D).	18
Figure 2.3. Example of an isometric drawing.	20
Figure 2.3. Inspirational sketch for a comic gag in a Mickey Mouse cartoon.	21
Figure 2.4. A storyboard from Walt Disney’s production of “Peter Pan.”	23
Figure 2.5. A UML Activity diagram (left) and use-case diagram (right).	25
Figure 2.6. A screen shot of Denim from UC Berkeley.	27
Figure 2.7. A Screen shot of a Director project showing the stage (upper left), cast (bottom), and score (upper right) in separate windows.	29
Figure 2.8. A taxonomy of graphic productions.	42
Figure 2.9. Hansen’s “Graphic Tools.”	43
Figure 2.10. A storyboard being presented by a story artist.	51
Figure 2.11. An example of a type 1 graphic from ETR&D. Notice the specific content in the graphic.	56
Figure 2.12. An example of two type 2 graphics from ETR&D.	57
Figure 2.13. An example of a type 3 graphic from ETR&D.	58
Figure 2.14. Dick and Carey’s model for “Systematic design of instruction” as an example of a type 4, design process diagram.	59
Figure 2.15. An example of a type 5 graphic.	60
Figure 2.16. Authorware presentation’s behavior palette (far left) and several flowlines.	72
Figure 2.17. Simplified job map for level 1 flight attendants.	73
Figure 2.18. Program instructional flow from Twitchell.	75
Figure 2.19. Example design drawings from May.	76
Figure 2.20. An example of an E ² ML goal mapping diagram showing dependencies.	81
Figure 2.21. An E ² ML action diagram.	82

Figure 2.22. An example of an E ² ML activity flow diagram.	82
Figure 2.23. The integrated vocabulary of the MOT representation.	83
Figure 2.24. A MOT diagram showing both a meta-knowledge representation an a learning scenario.	84
Figure 4.1. Photograph of the white board at the conclusion of the Biology 100 first design meeting. (Note: all photographs in Chapter 4 have been enhanced to increase legibility.)	107
Figure 4.2. Board at the end of the second Biology 100 meeting	111
Figure 4.3. Steven’s Outline for another project, Biology 120.	114
Figure 4.4. The list for Biology 120 written by the client, Earl.	115
Figure 4.5. White board after Kyle and Natalie’s initial Breeze tutorial meeting. Note the “diamond” (triangle) in the lower right.	118
Figure 4.6. Kyle’s storyboards. Kyle presents three options with two or three screen representations for each one. The tabbed style on the left was selected.	119
Figure 4.7. Natalie’s storyboard shows some concern with screen layout, but is more concerned with content and flow.	120
Figure 4.8. The white board at the conclusion of the second meeting with Natalie and Kyle. Kyle’s proposed screen layout/metaphor is in black on the left. The remainder, in blue ink, is the integration of that user interface with Natalie’s flow diagram. (Smudges in the original.)	121
Figure 4.9. The paper copy of the white board diagram after Natalie and Kyle’s second meeting.	122
Figure 4.10. The white board at the conclusion of the first Media Ethics meeting. Note especially the diagram at the bottom, starting with “Video” on the left, and moving to “Assessment Retrospective” on the right.	125
Figure 4.11. The left side of the white board during the second Media Ethics meeting.	127
Figure 4.12. Lower right side of the white board. Compare with the bottom of Figure 4.10.	127
Figure 4.13. A formalized diagram of the strategy for the Media Ethics case study simulation.	130
Figure 5.1. A set of storyboards from another of Steven’s projects, Speech Science.	137

CHAPTER 1—INTRODUCTION

Murphy (1992) asks, “Is instructional design truly a design activity?” After comparing instructional design (ID) to the general practice of design (as found in architecture, industrial design, engineering, etc.), he concludes, “...it can be argued strongly that instructional designers are truly involved in design activities” (p. 281). “...instructional designers need to recognize their links with the wider world of design” (p. 282). Rowland (1993) conducted a similar analysis and similarly concluded, “Designing instances of instruction, or more generally, planning and preparing to instruct, can be considered a subset of designing, and the defining characteristics...for all types of design appear to hold true for ID.” (p. 87) Speaking of the literature on ID, Rowland adds that the results of his study, “...match studies of design processes in other fields, but contradict views in the literature on ID, especially those representing a purely rational perspective” (p. 90). Murphy (1992) is emphatic: “Thus far, it appears that not much has been done on the design skills of instructional designers,” and warns, “All you instructional designers out there, look and learn from the design world. You ignore it at your peril” (p. 282).

In that larger design world, as in ID, design takes place in the gap between the mind of the designer and how the problem and solution are represented; design is the bridge between the conceptual world within and the physical world without. Simon (1996) puts it this way: because the gap is, “...centered precisely on this interface between the inner and outer environments; [design] is concerned with attaining goals by adapting the former to the latter” (p. 113). Bridging this gap requires a process of externalizing the designer’s conceptual

world. This externalization may be expressed verbally, visually, or physically—with words, drawings, or models.

For many fields of design, one fundamental bridge is *drawing*. Archer (1992) observes, “It has sometimes been said that drawing is the language of design. There has certainly been an intimate relationship between drawing and design from time immemorial...All the design professions today rely heavily upon drawings of various types for both the development of ideas and the communication of findings” (p. 7). Arnheim (1995) reports, “The function and nature of [drawing] is inseparable from that of the design it serves. The creative process of designing, being an activity of the mind, cannot be directly observed. The [drawings], done for the eyes and being directed by them, make some of the design plans visible” (p. 74), which makes drawing the perfect bridge across “Simon’s gap,” identified above (See also Goldschmidt, 1991).

Robbins (1994) has pointed out, “Because drawing is used to communicate ideas and to instruct others about a design, it is often seen as a language. Architects, when speaking about drawing, assume...that drawing may be construed to be a language or quasi-linguistic order of communication” (p. 27–28). Design drawing can be considered a language of design.

In ID, visual representations serve two very different purposes. First, visual representations, including drawing, are used during design as part of the design process to represent some aspect of instruction before it has been produced or presented. This may be in the form of storyboards, flowcharts, etc. Because the product of ID is instruction, visual

representations may also serve as part of the content being produced. These may take the form of illustrations of the content or diagrams of concepts, etc.

The latter—visual representation of content—has been studied extensively to determine how it contributes to learning. Unfortunately, the former—visual representations that are used to further the design itself—have not. It is difficult to find literature on the subject of design drawing in ID (though there is ample research on visualization in content). Indeed, Schatz (2003) did a small literature review where he noted that it is difficult to find literature on design thinking or design methods in ID, much less a specific method like design drawing. It is a paradox that a field that relies so heavily on visualization for the outcome of its designs has not studied their use in its process. In spite of the apparent similarities between ID and other design fields, and the importance of drawing to design in those fields, design drawing as a tool or skill of ID has not been adequately addressed.

One reason design drawing should be studied is to better understand design thinking, to improve it. Moore (2000) says, “Drawing, as many practitioners rather than design theorists report, is an analytical skill...” (The Media section, ¶5). Lockard (1977) observed,

During the design process, two different kinds of representational tools are needed. In the earlier analytical, conceptual stage designers need quick abstract representations of facts, precepts and concepts that can keep pace with their thought process and communicate it to others...drawing is still the most flexible and efficient means of representation. (p. 13)

Referring to the history of engineering design, Baynes (1992) identified five kinds of drawings connected with design. He named them (1) designers' drawings, (2) project drawings, (3) production drawings, (4) presentation and maintenance drawings, and (5)

technical drawings. These are roughly chronological to the design process. Of them, only the first three (designers' drawings, project drawings, and production drawings) serve to bridge "Simon's gap," that is, to further the design. The latter two are created after the fact (after a thing is made) to show it off, to maintain it, and to explain or document it. The first two roughly correspond to McKim's (1980) exploratory and developmental purposes of design drawing and the third to communication of the design. It is specifically these first three on which this study is focused.

Statement of the Problem & Significance of the Study

It may be that the choice of mode of expression contributes or limits the kinds of ID decisions that can be made. Referring to language, Vygotsky (1986) has observed, "Thought is not merely expressed in words, it comes into existence through them" (p.218). He goes on, "The structure of speech does not simply mirror the structure of thought; that is why words cannot be put on thought like a ready-made garment. Thought undergoes many changes as it turns into speech; it finds reality and form" (p. 219).

One of the assumptions of this study is that what Vygotsky said of verbal language is also true of a design language like drawing. Henderson (1998) conducted a study of engineers where she discovered a connection between forms of representations and participation in the design process: "(1) design cultures are intrinsically tied to the way in which their representations are constructed because such representations—sketches, drawings, prototypes—are the heart of design work; [and] (2) such design tools can engage or restrict participation in the design process..." (p. 139).

Assumptions

This study assumes that the value placed on design drawing in other fields is, in fact, legitimate. Jones (1970) derided “design by drawing,” but retreated a few years later (1992) when his proposed substitutions for “designing by drawing” were misapplied. For the most part, the value of drawing itself, as a design language or tool in other fields, is never questioned; rather, it is studied to better understand it. This study makes that same assumption.

A second assumption made by this study is that engineering, architecture, industrial design and other design fields are similar enough to ID to warrant the comparison. In spite of Murphy’s (1992) and Rowland’s (1993) assurances that they are, ID and those other fields may be sufficiently different that a tool or language that applies to one may not apply to the other. This study assumes that they are similar enough, that the subject ought, at least, to be considered.

The third major assumption follows from these two: that the practice of ID could be strengthened if instructional designers were more aware of how drawing contributes to design thinking and were acquainted with drawing as a way of representing design ideas. McKim (1980) encourages designers to learn many graphic representations to aid in their design skill: “Thinkers who have a broad command of graphic language not only can find more complete expression for their thinking but also can recenter their thinking by moving from one graphic language to another” (p. 134).

Definition of Terms

Drawing is a loose term that may refer to everything from rough sketches to polished images. For purposes of this study, we will define *design drawings* as all of those visualizations created in the service of design or construction of the designed thing, regardless of how refined they are. These can take on many forms. Some drawings, especially in the early stages of design, can be untidy and informal. They may be made up of messy circles and roughly drawn arrows on a napkin, doodles in the borders of a meeting agenda, or visually grouped text on a whiteboard. As Baynes (1992) points out, these types of drawings, "...are often very individual in style. It is usually this kind of drawing that people have in mind when they say that something was 'designed on the back of an envelope'" (p. 27). As development of the design progresses, drawings become neater, more complete, less vague, and more formal, until they are either the precise forms needed for construction (such as blueprints) or an accurately rendered representational drawing we usually associate with the term drawing (like an architectural perspective rendering).

For many authors, *sketching* refers to the very rough drawings made very early in the design process. Other authors use the terms *sketching* and *drawing* interchangeably. Other words used include *graphics*, *representations*, *models*, and *visuals* or *visualizations*. *Sketching* should probably be considered a subset of drawing, which can include both highly polished efforts as well as rough ones. For purposes of consistency in this study we shall use the term *drawing* for all of these.

Additionally, it is the nature of instruction—the product of ID—to include visual representations. As noted above, drawings of this type are part of the product of the

instructional design, and not part of the design process, which is the focus of this study. The drawing under consideration in this study occurs prior to, and in preparation for production, as part of design, and is *not* the visualization used in instructional materials themselves. To maintain this distinction, I will use the term *design drawing* throughout this study to refer to drawing that serves the design of a product, and *content drawing* to specify drawing that is part of the content or instruction. This differentiation will be further developed in Chapter 2.

Organization of the Study

The next chapter of this study, Chapter 2, is a review of the literature. In order to make a comparison between design drawing in ID and in other design fields, one has to have some understanding of design drawing in those other fields. Chapter 2 provides a foundation for this comparison by reviewing the research and literature on this subject as it has been observed in other fields. This provides not only a comparison, but a vocabulary for discussing design drawing as observed in ID. An additional part of the literature review consists of a search for design drawing in the literature of ID.

In Chapter 3 we will review the methodology used for the case study of this dissertation. In it I discuss the reasons BYU's Center for Instructional Design (CID) was selected, how the study was conducted, how the analysis was done, and follow up procedures taken. Chapter 3 also includes a discussion of measures taken to insure validity.

Chapter 4 contains three of those case study observations. Detailed descriptions of design drawing viewed *in vivo* in meetings, conversations, and interviews with creators and users of design drawing. These observations are discussed and conclusions drawn in Chapter five where the comparison with other fields of design is completed.

The amount of attention given the subject of design drawing in other design fields stands in stark contrast to the dearth of it in ID. However, there is a growing interest in ID about languages of design (e.g., Boot, 2005; Botturi, 2003; Figl & Derntl, 2006; Schatz, 2003; Seo & Gibbons, 2003). Design drawing is one such design language. It makes sense to study this traditional design language as used in other fields as knowing more about it may benefit ID. Such an understanding may inform us about creativity in ID, and about what ID itself is capable of with the added use of such a skill. Indeed, one way to improve the skills of instructional designers may be to give them a broader language with which to express their designs by inculcating them with a culture of drawing more like that of other design fields. However, before we can begin to study design drawing for ID in that way, its current usage needs to be explored and understood.

Purpose of the Study

The purpose of this study is to observe the use of design drawing in ID with the goal of being able to compare it with that of other design fields such as architecture, engineering, and industrial design. Design drawing as it is currently used in ID needs to be observed to discover the current state of usage. This understanding can then serve as a foundation to learning more about this design language.

Research Question

The principal question this study seeks to answer is: “How is design drawing used in ID, and how does this compare with its use in other design fields?”

CHAPTER 2—LITERATURE REVIEW

This review of the literature of design drawing will draw from two areas, each in a section: design drawing as studied outside of instructional design (ID), and evidences of and writings about design drawing as found inside ID. These sections are called, respectively “Research in Design Drawing” and “Evidences of Design Drawing in ID.”

It is important when reviewing a topic about which little has been written, to broaden the search to examine analogous research in other fields. Such is the case with the subject of design drawing in ID. In the general design methodology literature, the research on design drawing is widespread. The first section of this literature review introduces the reader to many of the significant topics surrounding design drawing found in that broader literature. This includes a discussion of the importance of representations to design, examples of design representations in other fields, the preponderance of design drawing as one of those types of representations, and a number of specific topics about design drawing.

In contrast to the recognition it enjoys in the general literature of design studies, design drawing does not seem to have the same history or importance in ID, though, there is some evidence of it in the practice and literature of ID. The second section will present the results of a search for evidences of design drawing in ID as well as a review of the literature of ID concerned with design drawing. This discussion will begin with a typology of illustrations in research to assist in differentiating between design drawings and other types of images. Then, examples of design drawing in ID research journals, textbooks, case studies, and software are all discussed. A review of research literature about this topic finishes this second section.

Before these subjects can be adequately addressed, a definition of the term design drawing needs to be considered, including some of the alternate terms that will be encountered in this review of the literature. This is a more detailed discussion of the definitions found in Chapter 1.

Definitions

Design

To understand the term design drawing, it is important to understand what is meant by *design*. Jones (see 1992, pp. 3–4) quotes several descriptions of design. Here is a sampling of those descriptions:

A goal-directed, problem-solving activity (Archer, 1965)

Decision making in the face of uncertainty, with high penalties for error (Asimow, 1962)

Simulating what we want to make (or do) before we make (or do) it as many times as may be necessary to feel confident in the final result (Booker, 1964)

The performing of a very complicated act of faith (Jones, 1966a)

The imaginative jump from present facts to future possibilities (Page, 1966) (p. 1–2)

Some common threads that run through these selected definitions include “goal-directed,” “decision making,” “simulating what we want,” “imaginative jump” from present to future, and, most succinctly, “faith.” Merging these ideas suggests that design is an act of faith carried out to influence the future state of something. Simon (1996) says “Design...is concerned with how things ought to be, with devising artifacts to attain goals” (p. 114). Another idea common to all of these definitions of design is that this future outcome is

determined by creative effort—by some kind of activity, involving making, performing, or devising some thing.

One dictionary (*Oxford American Dictionaries*, 2005) defines the noun *design* as, “1a. a preliminary plan or sketch for the making or production of a building, machine, garment, etc. b. the art of producing these.” Note that the definition of the act of design makes the inclusion of design representation or expression (the “preliminary plan or sketch”) a necessary part of the definition. In other words, without the representation of a design, there is no design.

From these definitions, we might conclude that design is a solitary work, carried out by an individual without interaction with others. While this may sometimes happen, many authors imply that design is very much a social activity. Schön (1987) has identified design as a form of reflective dialogue. Bucciarelli (1994) calls design a shared vision, a social construction:

The design is the shared vision, and the shared vision is the design....To the extent that it exists as a whole, it is a social construction—dynamic, plastic, given nuance and new meaning at each informal gathering of two and three in a hallway or at formal meetings such as scheduled design reviews. (p. 159)

In addition to its social nature, Nelson (Saba, 2005) adds another interesting dimension to the definition of design—design as service, when he says,

We differentiate design from art and science by the concept of service. Design is defined as service on behalf of someone else—a contractual relationship. Artists and scientists engage in forms of service legitimately focused more on their own interests. Artists express their emotions and feelings; scientists express their curiosity about the world. Designers, however, serve the needs and desires of others. This does not mean that designers are not aesthetic or rational, they are both, but most importantly, they are empathic. (Question number 5, ¶3)

The term design as used in this study, refers only to the specific effort of creative planning. It does not refer to the entire cycle of activities sometimes associated with the term *instructional design*, as canonized in the common acronym ADDIE (for Analysis-Design-Development-Implementation-Evaluation, a process or model commonly mentioned in connection with ID and Instructional Systems Design, ISD). ADDIE is inclusive of all the activities involved in instruction: planning, producing, testing, implementing, and maintaining. In most design fields, design refers only to the creative planning step, the first 'D,' in ADDIE. To be consistent with the usage and literature in these fields, and to narrow the scope of interest in this study, I will use the term design and instructional design (including the initials ID) to refer to the creative planning step, not the entire range of activities.

To summarize, design is a purposeful activity of preparation or planning. It has social aspects including negotiation, compromise, and communication. It also has a characteristic of service: design, especially ID, is done in the service of another.

Drawing, Sketching & Other Terms

Drawing (the verb) refers to the act of making marks or images on any suitable surface, as well as (the noun) to the resulting image or design itself. Drawings can be made for artistic or technical purposes. Synonyms for the noun *drawing* include: sketch, picture, illustration, representation, portrayal, delineation, depiction, composition, study, diagram, outline, design, plan (*Oxford American Dictionaries*, 2005). The literature about drawing, especially design drawing, uses a variety of these terms.

Of particular interest to this study is the literature about the impromptu drawings that take place during the initial phases of design (the “back-of-the-envelope” kind). The design literature most often refers to this kind of drawing as *sketching*. In this study, I will occasionally use both terms.

Drawing and sketching, as used in this study, are not the same as other kinds of images mentioned, such as the polished formal graphics designed for presentation or publication. Since the term sketching implies some level of roughness or lack of concern for detail, it does not accurately describe these visual images. When that is the case, other words such as *representation*, or even the generic word *graphic*, may be employed.

Another word used to describe a representation is *model*. In design, the word is usually an additional term for representation of the designed thing. Archer & Roberts (1992) equate models with other forms of representation.

The [mental] image is usually externalised through models and simulations, such as drawings, diagrams, mock-ups, prototypes and, of course, where appropriate, language and notation, or it can be embodied in the construction or enactment of the emerging responses. These externalisations capture and make communicable the concepts modeled. (p. 10)

As noted in Chapter 1, the content of instruction itself makes use of visual representations and models. These content drawings or content images are part of the product of the design, and are not part of the process of design; it is the process which is the focus this study. The drawings under consideration in this study occur prior to, and in preparation for production, as part of design, and are not the images used in instructional materials themselves. In the discussion of types of images found in ID research literature later

in the chapter, I will further break down the various types of drawings or representations associated with ID to make the distinction more clear.

Design Drawing and Design Sketching

With these clarifications, I can appropriately combine the terms design and drawing or sketching to identify the subject of this study: *design drawing*, which is the act of putting images on paper or other suitable surface to serve the purpose of planning a designed thing. Design drawings assist in the creation of shared vision, and are usually in the service of some purpose other than that of the designer. “[D]esign drawing is a particular kind of drawing, clearly different from the more conventional and long formalized Art and Drafting in its purposes, methods, and values” (Lockard, 1977, p. 1).

Research in Design Drawing

The last decades of the 20th century saw a great deal of research in the study of design methodology as a general field, where the various approaches to creative design activities of architecture, engineering, industrial design, graphic design, software engineering, and others were discussed, compared, and analyzed, in an effort to improve methods and process models. This new field of inquiry was called variously design methodology, design theory, design science, and design studies. The importance of this field is evident by the number of research-based journals in design theory and methodology, such as *Design Issues*, *Design Journal*, and *Design Studies*, among others (Kays, 2003). This literature (in which ID is not generally included) contains a wealth of information on design drawing and its relation to the design process.

This section begins by examining that literature to understand the importance of design representations and models to design. A survey of design representations and models in various design fields is presented. It will be noted in these examples that drawing is the most common and most valued means of design representation and modeling. This lays the groundwork to discuss some specific topics about how design drawing benefits the process of design.

The Importance of Representations & Models to Design

Designers rely heavily on representations and models to accomplish their work.

According to Goel (1995),

Design, at some very abstract level, is the process of transforming one set of representations (the design brief) into another set of representations (the contract documents). However, not only are the inputs and outputs of the of the design process representations, all intervening transformations are also typically done on representations. (p. 128)

Saddler (2001) observed, “We use sketches, diagrams, specifications, even verbal descriptions throughout the design process to make the concepts in our heads tangible and communicable.” A representation or model is a referent (a symbol or metaphor) for some other (real-world) thing. Baynes (1992) says,

The term ‘model’ is used by scientists, mathematicians, technologists, and designers to mean something that stands for something else. In general, models are powerful because they isolate an aspect of reality and allow us to represent, interpret, manipulate, or control it. Models have predictive power because...they can be ‘run’ to simulate what will happen if proposed changes are carried out. They are indispensable for design activity because they allow designers to develop their designs and understand their likely effects before they are put into practice. (p. 18)

Goel (1995) adds,

This [practice of using models in design] is not an accident... Recall that design typically occurs in situations where it is not possible or desirable to tamper with the world until the full extent and ramifications of the intervention are known in advance. After all, we only get one 'run' on the world. Every action is irrevocable and may have substantive costs associated with it. Thus, it is not surprising to find that designers produce and manipulate representations of the artifact rather than the artifact itself. All the reasoning and decision making (including performance prediction) is done through the construction and manipulation of models of various sorts, including drawings, mock-ups, mathematical modeling, computer simulations, and so on. (p. 128)

Henderson (1998) observes, "design cultures are intrinsically tied to the way in which their representations are constructed because such representations—sketches, drawings, prototypes—are the heart of design work" (p. 139).

Examples of Representations & Models

The following are some examples of the representations and models that selected design fields rely on to accomplish their work.

Graphic design. In graphic design, a small, quickly-drawn sample drawing known as a *thumbnail sketch* is the fundamental visual design representation (see Figure 2.1). It forms a direct link between the design process and the designed thing because the earliest design sketch has a lot in common with the final product visually. In the process of graphic design, it is possible that dozens—even hundreds—of these small sketches will be drawn to assist in the design of a book cover, a poster, or an advertisement. A few of these thumbnail sketches are then further developed to become rough sketches, which are then winnowed down to a draft or two, sometimes a mock-up or a prototype will follow, and eventually the design is made into the final product. The value thumbnail and rough sketches provide is in an economy of effort: using them the designer can "try on" or test many designs without going

to the expense of full production. They give her an idea whether or not a particular layout will work for its intended purpose.

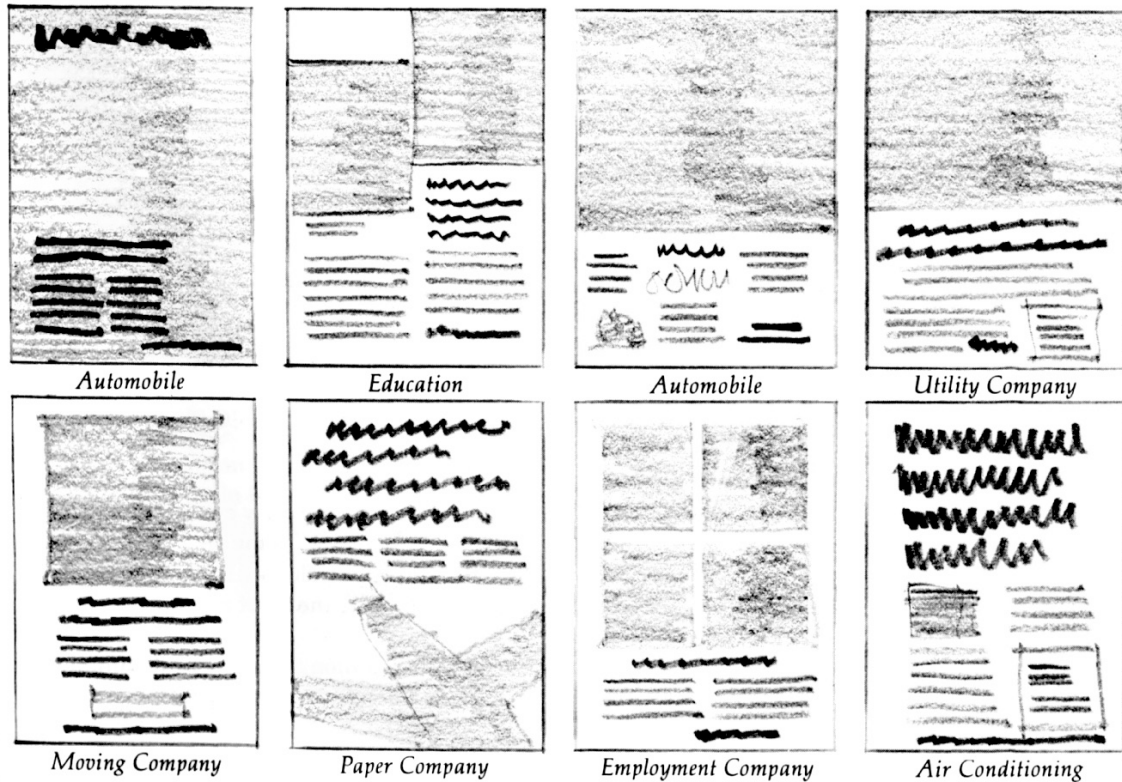

Figure 2.1. Thumbnail sketches of assorted advertisements found in Time magazine.

Note. From *The language of layout* (p. 27) by B. Donahue, 1978, Englewood Cliffs, NJ: Prentice-Hall. Copyright 1978 by Prentice-Hall, Inc.

Even the mock-ups and prototypes allow changes to be made in the design stage, before costly production begins.

Architecture. Before architects create the representational models most often associated with architecture (drawings and models that look like the final product in some respect—such as blueprints and perspective drawings) they will often create much more symbolic diagrams to experiment with important design considerations, like traffic patterns or capacity, in an abstract way.

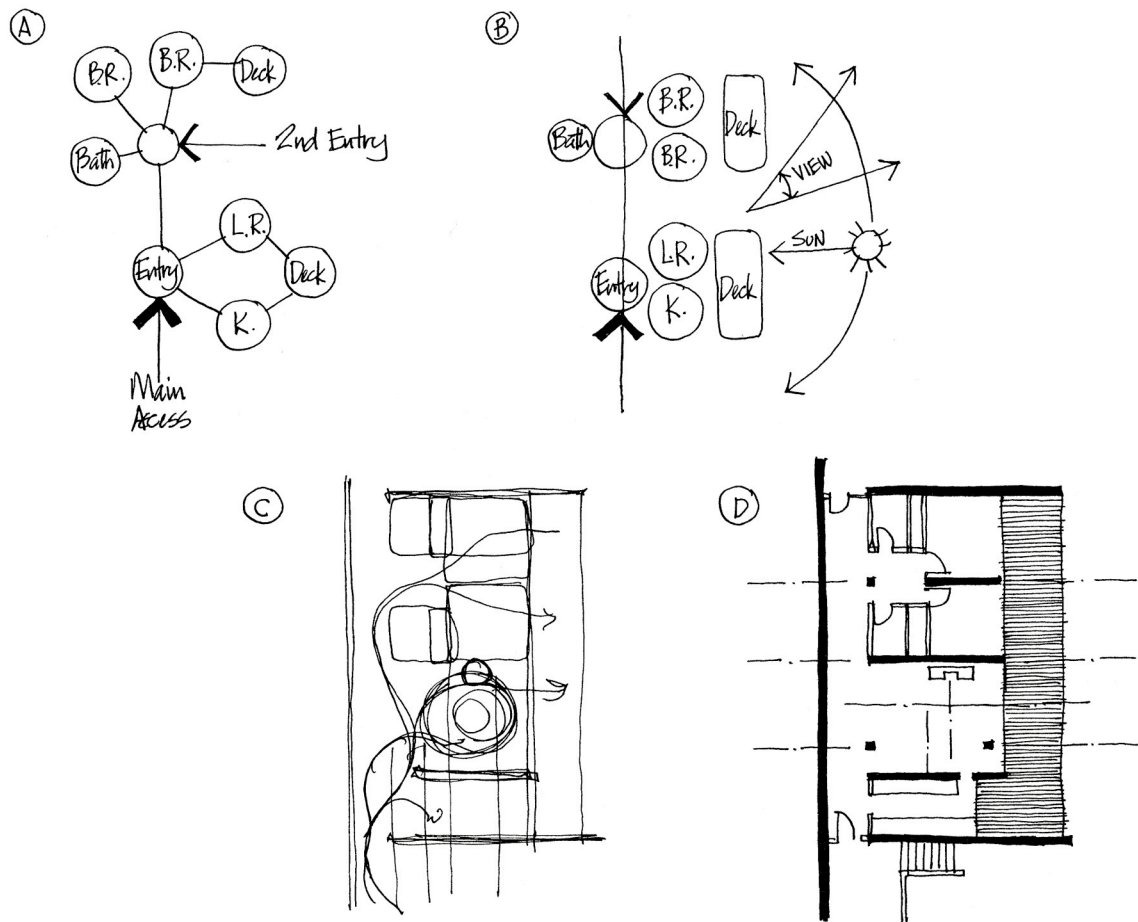

Figure 2.2. Progression from a bubble diagram (A) to architectural plan (D).

Note. Adapted from *Graphic problem solving for architects & builders* (pp. 28–29), by P. Laseau, 1975, Boston: Cahners Books. Copyright 1975 by Cahners Books International, Inc.

Because these abstract representations represent proposed relationships between spaces and proportions, etc., there is a logical progression from them to the more concrete, formal plan or drawing usually associated with architectural work, as can be seen in Figure 2.2. These include floor plans, cross sections, elevations, and perspective drawings. (See Haynes, 1989, for definitions of these terms.)

The move from abstract to concrete permits design details to be worked out in an inexpensive medium (drawing) before client approval and the costly work of building construction begins. Blueprints and other formal plans are the result of these activities, which

final drawings are used to communicate with the builder regarding the specifics of construction.

Engineering. As noted in Chapter 1, Baynes (1992) defined five stages through which engineering drawing evolve. They are (1) designers drawings, (2) project drawings, (3) production drawings, (4) presentation and maintenance drawings, and (5) technical illustrations. The first of these, designer's drawings are often found in notebooks and can be highly individual in style and form (like the famous notebooks of DaVinci). They reflect that stage of development when the engineer is trying out broad alternatives and outline proposals. "It is usually this kind of drawing that people have in mind when they say that something was 'designed on the back of an envelope.'" (Baynes, 1992, p. 27) These drawings, from the earliest stage of design, leave vague those parts of the design about which the designer is not concerned. Project drawings are very similar to designer's drawings in their broad application and vagueness, but use standard conventions rather than idiosyncratic forms of designer's notebook drawings.

As the design progresses, these simpler earlier forms grow into the more formal production drawings—what most people think of as "engineering drawings." The structure or form of engineering drawings of Baynes' types 3, 4, and 5, change less than their purposes. Production drawings cover every detail of a design for manufacturing; presentation and maintenance drawings record the final manufactured product to show it to others or help maintain it; and, the technical illustrations are additional types of presentation drawings to a different audience.

These final formal drawings are often the familiar *multi-view orthographic projections*, *sectional drawings*, or *isometric projections*, which correspond roughly to architecture's plans, sections, elevations, and perspective drawings (See Goetsch, Chalk, Nelson, & Rickman, 2005). *Multi-view projections* show two or more views of an object (top, side, front) sometimes *sectionally* (viewed as though it was a slice of the object). Engineering drawings are sometimes “exploded” (showing parts spread out along an axis) to make assembly easier to understand, and are sometimes drawn *isometrically* (where measurements of all three dimensions are the same, as opposed to a perspective drawing; see Figure 2.3). The drawings made by industrial designers are clearly related to these engineering drawings, as all these

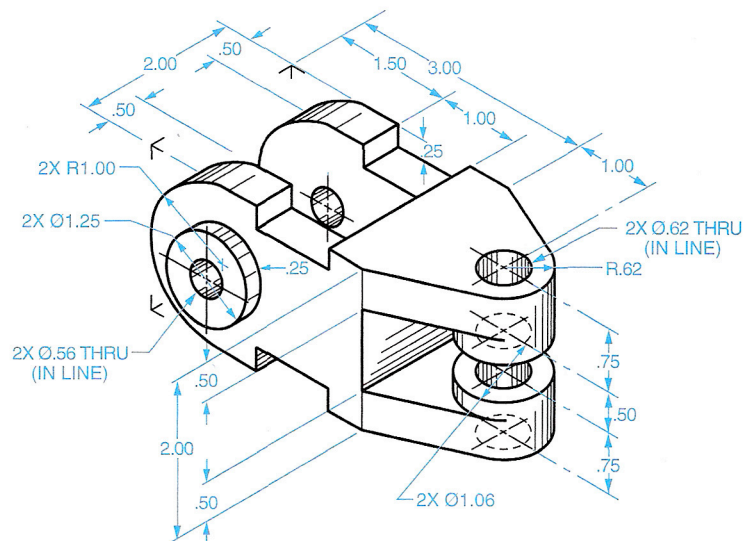

Figure 2.3. Example of an isometric drawing.

Note. From *Technical drawing* (5th ed.), by D. L. Goetsch, W. S. Chalk, J. A. Nelson, & R. L. Rickman, 2005, Clifton Park, NY: Thomson Delmar Learning. Copyright 2005 by Thomson Delmar Learning.

types of drawings are used, plus the architect's perspective drawing (where things close to the viewer appear larger in the picture). Later forms serve to provide manufacturing detail as well as to document and present the results of design.

Motion pictures. To create animations, Disney employs inspirational sketch artists and other to clarify the look of the final film. About these individuals, Canemaker (1996) has observed,

The ‘inspirational sketch’ or ‘visual development’ artists, designers, and stylists create conceptual artwork that explores the visual possibilities in a literary property. Through daydreams and doodles they attempt to ‘find’ the film: the appearance of the characters and their relationships, the action’s locale, a sequence of mood and color, costume and set designs, suggestions for the staging of scenes, gags, and production’s over style. (p. ix)

Canemaker goes on to present inspirational sketches that range from the very rough pencil sketch (like the rough sketch for a humorous gag in Figure 2.3) to fully developed oil paintings that the Disney Studios has used for that purpose. Other motion pictures use this method as well. For example, the famous director Cecil B. DeMille hired religious artist

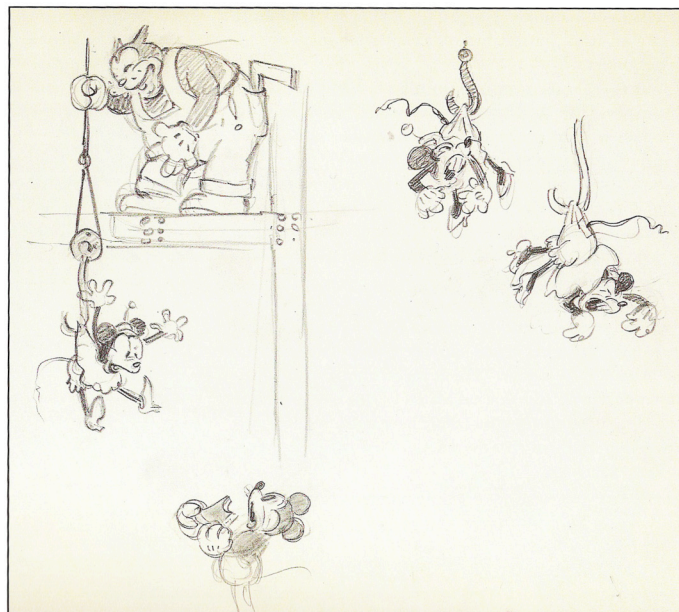

Figure 2.3. Inspirational sketch for a comic gag in a Mickey Mouse cartoon.

Note. From *Before the animation begins : the art and lives of Disney inspirational sketch artists* (1st ed.) (p. 23), by J. Canemaker, 1996, New York: Hyperion. Copyright 1996 by Disney Enterprises, Inc.

Arnold Frieburg to produce a series of paintings on the story of Moses for his epic film “The Ten Commandments.” These inspirational paintings helped set the “look” of the sets, costumes, make up, and shot selections for the movie.

Another area in which motion pictures have a tradition of design drawings is the storyboard. During the production of animated shorts, Walt Disney’s animators discovered that they could save a lot of effort if they told their story visually rather than in a script. Initially animators drew a hybrid script with descriptive text along the left side of the paper, and sketches for the animation in a frame on the right. Eventually, however, the drawings representing frames of the motion picture were pinned onto large boards so they could all be seen at once, and the artist not only drew the storyboards, but “presented” (performed) them to a story committee made up of animators, directors, etc. Figure 2.4 is an example of one of these storyboards, and Figure 2.10, later in this chapter, shows a storyboard performance. The advantage of this method to movie making, and to animated movies in particular, is that it gave the animators a clearer idea of what was wanted before they began the arduous work of drawing animations, frame by frame. This time- and cost-saving method soon migrated to movies other than animated ones, and now storyboards are *de rigueur* in the movie industry. (M. Simon, 2000).

Storyboards have the look of a comic book; they represent what the camera (and hence, the audience) will see, including actors and set, along with motion, the camera’s perspective, and the action in the scene. An elaborate “vocabulary” of drawing methods are used to represent this space- and time-based aspects of a scene that are similar to a comic

strip. For example, the storyboard artist may draw a scene larger than the frame, and use boxes and arrows to indicate zooming in or panning directions to the camera.

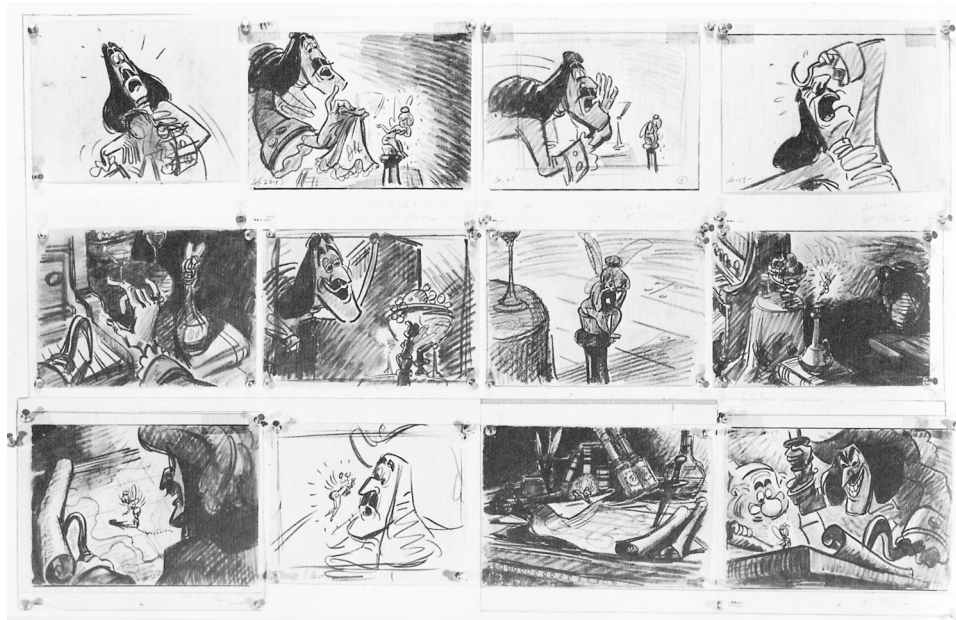

Figure 2.4. A storyboard from Walt Disney's production of "Peter Pan."

Note. From *Disney animation : the illusion of life* (p. 198) by F. Thomas & O. Johnston, 1981, New York, N.Y.: Abbeville Press. Copyright 1981 by Walt Disney Productions.

Software design. The complexities of major design concepts from software engineering are difficult to express verbally. Abstract concepts such as the sequence of operations in a software process, or the movement of data from one sub-system to another are made easier to comprehend with a visual representation. For example, a sequence of operations can be illustrated with a flowchart; movement of information may be demonstrated using a data flow diagram (Budgen, 2003). In the later stages of design, software engineers may create prototypes to test some of the functionality of the final product.

One formal visual language for computer software design, Unified Modeling Language (UML), is gaining popularity even though it was originally created to support only

one particular approach to software design called Object Oriented Programming (OOP) (Alhir, 2003). In OOP, the computer code each “object” is encoded to stand independently, but also to influence the behavior of other “objects.” UML uses thirteen standard types of diagrams—called *views*—to help software architects, “...specify, visualize, and document models of software systems, including their structure and design” (Object Management Group, 2006). UML provides to its users a set of visual design terms with which to understand many of the aspects of a software program. UML represents the latter end of the design process, but simplified sketches of the diagrams must surely precede them.

By the time software design reaches the stage of being represented in UML, it is generally clear and unambiguous. This clarity may make it possible to use UML as a kind of visual pseudo-code which could be translated directly into computer code without the necessity of human programming (Alhir, 2003) and tools are currently under development which attempt this.

Human interactions with computers (user interface design, or Human-Computer Interaction, HCI) also rely on visual representations to understand how people with interact with computers. The powerful functions of computers have been made accessible to non-experts by the representation of those functions visually in graphic user interfaces (GUIs). Very often, user interfaces with computers are designed first as sketches on sheets of paper and tested with people before they are implemented in computer code. Like the role that the thumbnail sketch plays for the graphic designer, these user interface sheets make it possible

for the designer to “try out” a number of possibilities that can be increasingly refined before settling on the user interface to be coded. (Cooper & Reimann, 2003).

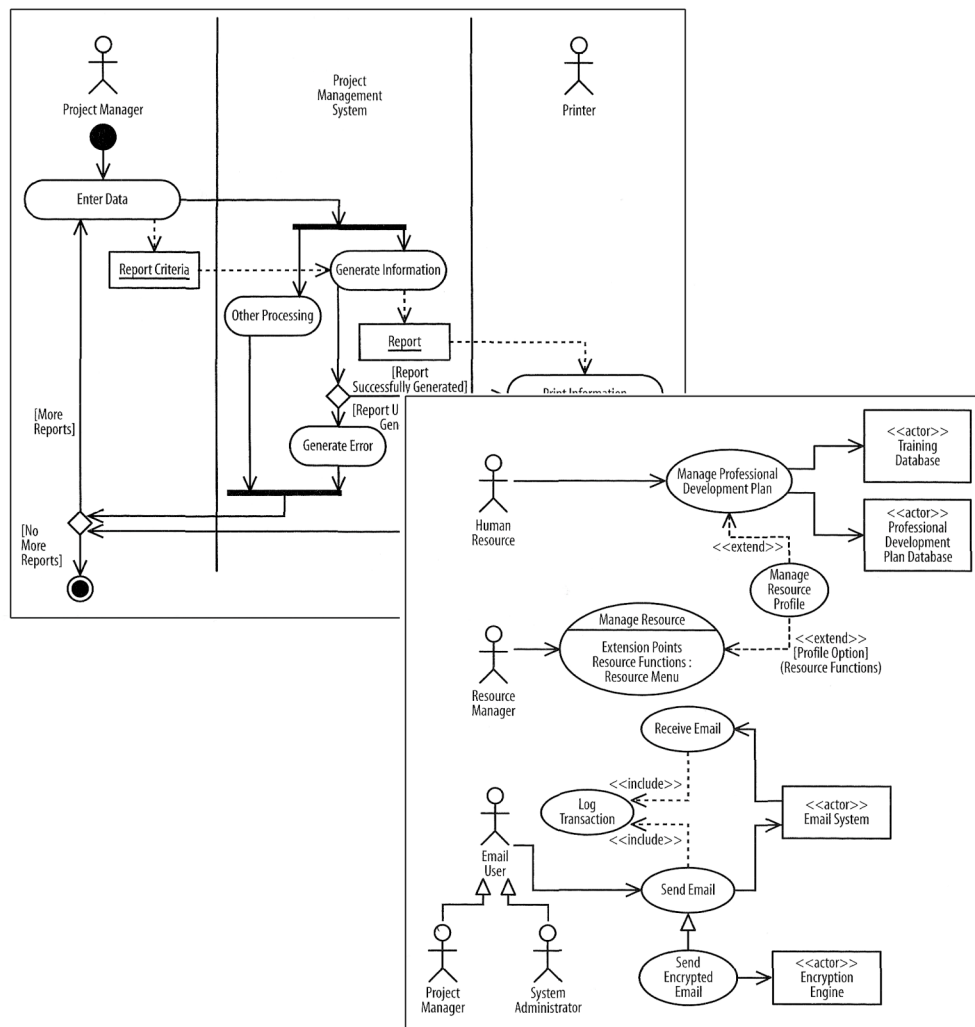

Figure 2.5. A UML Activity diagram (left) and use-case diagram (right).

Note. From *Learning UML* (1st ed.) (pp. 219 & 205) by S. S. Alhir, 2003, Sebastopol, CA: O'Reilly. Copyright 2003 by O'Reilly & Associates, Inc.

Web design. Web design traces its roots to both computer design, and modern media techniques of which moviemaking is a part. For this reason, both page-flow diagrams, (reminiscent of computer flowcharts, where each box represents a Web page) as well as storyboards (like those of movies; mock-ups, sometimes called *wireframes*, which are rough

sketches of what a proposed screen may look like) are used to document Web site design. Sometimes these two methods are combined: a page-flow diagram in which the boxes are “dressed up” to look like the actual pages (Phyo, 2003).

Another interesting approach is that of Van Duyne, Landay, and Hong (2003) who have borrowed from Alexander’s *A Pattern Language* (Alexander, Ishikawa, & Silverstein, 1977) and applied the concept of patterns to Web development. (Coincidentally, they have chosen to represent the pattern solutions as hand-drawn “back-of-an-envelope” drawings that accompany the narrative).

Experimental design software from UC Berkeley called “Denim” attempts to automate the sketching of Web designs using a graphic tablet (Newman & Landay, 2000). Boxes are drawn and labeled roughly, and can then be programmatically tied together using lines drawn between them—basically making the symbolic connection found on a flowchart diagram into a real functioning connection (see Figure 2.6). The program allows viewing the results from different levels of specificity, so rough visual design can be inserted at the lower levels of the diagram. This functional diagram (in the sense that it actually works!) is the foundation for a Web page flow or other flow.

Multimedia design. Multimedia is the combination of still pictures, sound, motion, and interactivity—usually on a computer—for informational or entertainment purposes. Because they employ multiple kinds of media, they also rely on many of the same techniques and representations that their base media use, such as thumbnails for still graphics; storyboards for motion video; flowcharts for interactivity, etc. In addition to the planning

and design of the separate elements that go into multimedia, there is also the planning and design of their combination. Many of the software tools used to produce (author)

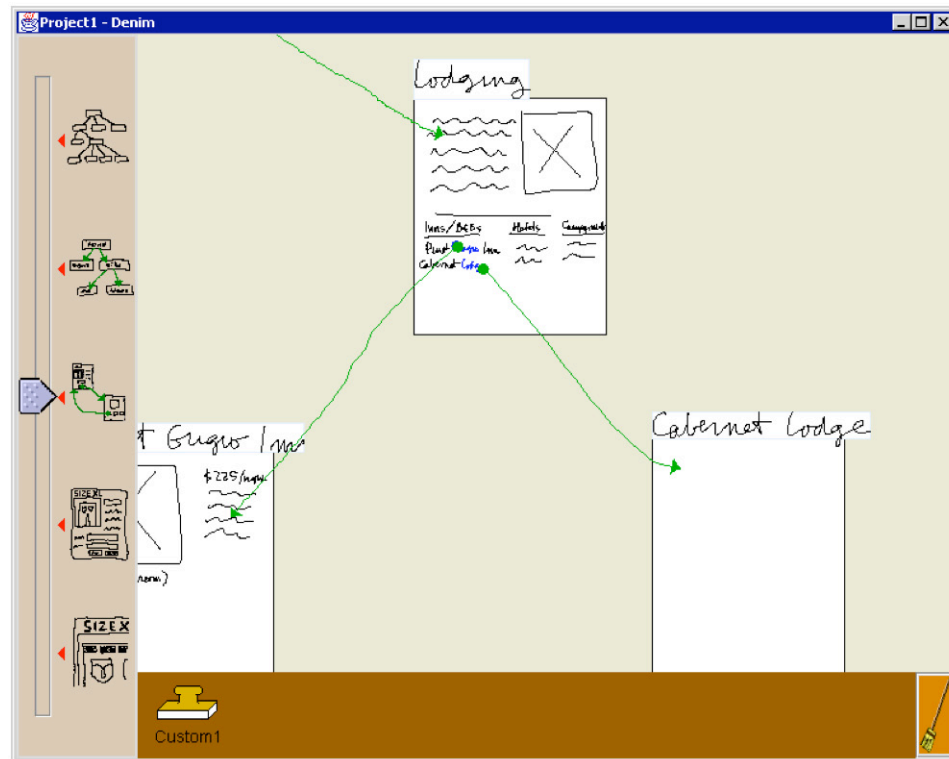

Figure 2.6. A screen shot of Denim from UC Berkeley.

Note. From "Sitemaps, storyboards, and specifications: a sketch of Web site design practice" by M. W. Newman & J. A. Landay, 2000, *Proceedings of the conference on Designing interactive systems: processes, practices, methods, and techniques*, pp. 263-274.

multimedia take advantage of graphic metaphors in their user interfaces to ease the difficult task of authoring. These metaphors employed by these tools are often design-drawing-related. Common multimedia authoring tools of this type include Macromedia *Director* and *Flash*, *mTropolis*, *Toolbook*, *HyperCard* and others. (*Authorware* belongs to this group of broadly used multimedia authoring systems with visual interfaces; but, because it was designed specifically for ID, it is discussed later in this chapter.)

Macromedia (now Adobe) *Director* is an example. To author multimedia, Director uses a combination of metaphors, all associated with a theater. The window called the *stage* is the actual location of the action. It is the *stage* that the audience or user will view and interact with in the final product. Because authoring uses a visual metaphor, you place things on the *stage* visually where you want them to be. If you need to modify the placement, you can literally drag the object where you need it to go. The objects that you place on the stage are called *cast members*. Cast members are held in a kind of visual table called the *cast*, from which these members can be dragged to the stage. Cast members include various kinds of graphic images, as well as sound, video, and interactive elements. Double-clicking on each cast member allows you to edit that cast member visually depending on its type (for example, text-based cast members are edited in a word processing environment, bit-mapped graphic objects are edited in a pixel-editing paint environment, etc.) The stage can change over time to create animation and interaction. To track this change you use the *score*, a kind of table showing all the cast members in rows, with each column representing a frame of animation. See Figure 2.7 to see examples of the stage, the cast, and the score.

Given their ability to portray ideas in multiple media, and their ability to allow student interaction, the value of multimedia to instruction is has been a topic of discussion for some time. It is interesting to note that many if not most instructional design multimedia is authored in these general tools (such as *Director* and *Flash*) rather than in tools specifically built for instruction (such as *Authorware*, discussed below).

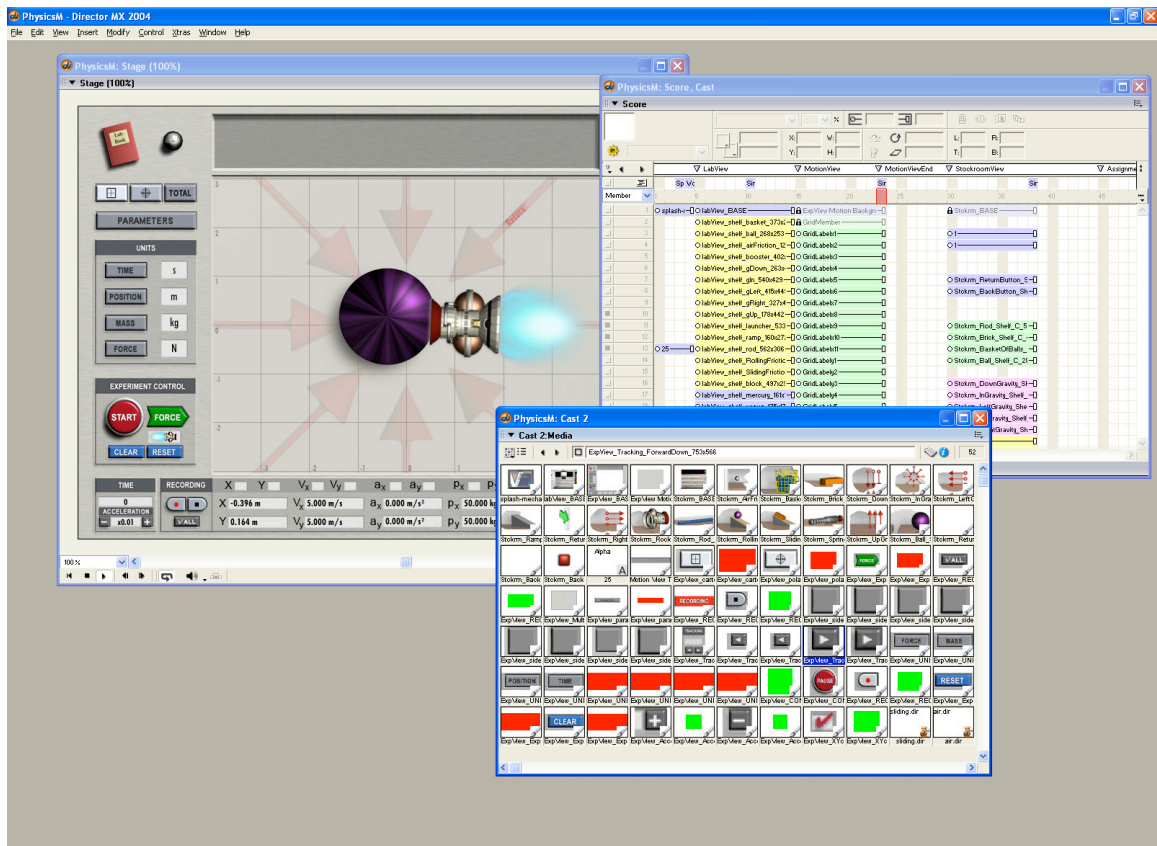

Figure 2.7. A Screen shot of a Director project showing the stage (upper left), cast (bottom), and score (upper right) in separate windows.

Information design—a first cousin to ID. There is a relatively new design field called information design which overlaps graphic design, software design, ID, and others (Bradford, Wurman, & Graphis Press Corp., 1996; Jacobson, 1999; Saddler, 2001) Information design appears to be a close cousin to ID as its goals are similar—the organization of information so that it influences human behavior. About representations in information design, Saddler has observed,

Some professions are disciplined about their representations, with standardized formats and formal systems of notation—for example, electronics schematics, architectural drawings, state/transition diagrams, and chemical process control diagrams. Information and interaction design, however, tend to be less disciplined, with a plethora of ill-defined forms and

conflicting nomenclature. Perhaps it's because the field is so broad, or because it's relatively young and its standards are still forming. Or perhaps it's because we're so facile at inventing new kinds of representations—we just can't resist the fun of creating a new kind of diagram instead of using something tried and true. Whatever the reasons, our most fundamental tools lack the communicative power and precision that we need. (p. 2)

Design Drawing is an Essential Part of Design

To this point, I have presented a number of examples of design representations and models in various design fields. A great number of these are paper-based: diagrams, sketches, and drawings—what this study calls design drawing or design sketching. In this section the relationship between design drawing and fields of design is explored. This section will introduce a number of important topics that explain why design drawing is so valuable to the design process. These topics include the relationship between design drawing and thinking, design drawing as a design language, stages and purposes of design drawing, the value of vagueness to design drawing, and others.

Drawing and design have a long history together. Archer (1992) says, “There has certainly been an intimate relationship between drawing and design from time immemorial...All the design professions today rely heavily upon drawings of various types for both the development of ideas and the communication of findings.” Baynes (1992) identified the development of design drawing in the late 18th century as the principle catalyst to the development of design as a separate discipline, which, in turn, helped to fuel the industrial revolution. However, the use of some kind of drawing to pre-plan work predates the industrial revolution by millennia. Shards of pottery and stone with coarse building directions on them have been found from ancient Egypt. (Baynes, 1992)

Press and Cooper (2003) pointed out that "...everyone can draw; however, designers are trained to develop this as an advanced form of communication" (p. 136). Lockard (1977) has observed that, "In...the design process, drawing is still the most flexible and efficient means of representation" (p. 13). This is in part because the speed and ease of production of free-hand sketches support design in important ways. According to Kivett (1998) free-hand sketches allow communication to be almost instantaneous, and drawing facilitates making of changes "on the spot" (¶1). Gedenryd (1998) asserts that,

Sketching is made up of very small and simple incremental steps, which yield to local control and high sensitivity to feedback. This, in turn, makes sketching into a highly fluid and efficient process, which supports the open-ended and conceptual nature of the design work which sketching is typically used for. (p. 145)

Goldschmidt and many of others assert that drawing is a vital part of design (Archer, 1992; Goldschmidt, 1991; Henderson, 1998; Moore; Ullman, Wood, & Craig, 1990). For example, Ullman, Wood and Craig say that,

The evidence both from research in cognitive psychology and from the protocol studies of designers points to the importance of drawing in the design process beyond the documentation of final designs. Not only are drawings the preferred form of data representation, for the designer, but they are a necessary part of the design process. Sketching as a form of drawing has been shown to have properties that make its use important in design. (Section VI, ¶1)

Many have speculated on the reasons for the close association between design process and design drawings. Some have investigated the relationship of design drawing to specific design activities of which drawing seems to be a part; others have looked at specific processes and properties of design drawings that support design. Still others have studied the close association between design thinking and drawing. What follows are summaries of these ideas.

Design drawing and thinking. Much of the literature about design drawing proclaims the close tie between it and thinking. So much so, that the rest of the topics in this section could be considered, more or less, to be subsidiary to this idea. As Robbins (1994) puts it, “Unless you draw something, you do not understand it” (p. 127).

Herbert Simon (1996) describes a gap that exists between the mind of the designer and the real world. Design could be defined as “...attaining goals by adapting the former [the mind of the designer] to the latter [the real world]...” (p. 131-2). Design drawing seems an ideal design device to fill Simon’s gap.

Design drawing aids the designer by reducing cognitive load during the design process. Because design sketches are an external representation, they augment memory and support information processing (Tversky, 2002). As already mentioned, according to Arnheim (1995),

The creative process of designing, being an activity of the mind, cannot be directly observed. The sketches, done for the eyes and directed by them, make some of the design plans visible. They not only supply the designer with tangible images of what his or her mind is trying out in the dimness of its own freedom, but they also permit the observer or theorist to catch a few stop-motion glimpses of the flow of creation. (p. 74)

It is probably this support of memory that gives design drawings, “...the capacity to transform our understanding of an issue, and, to some extent, free us from the narrowness of words, labels, and classification systems” (Hansen, 1999, p. 203). Laseau (1989), a theorist in design drawing, calls this close affiliation between drawing and thinking *graphic thinking*:

The term *graphic thinking* distinguishes the use of graphics in support of thought from graphics used in presentations. Graphics should play a significant role in design and problem solving, provoking thought and acting as catalysts for ideas rather than limited representations of products or decisions.”(p. 9, italics in original)

Another view of drawing is similar to Vygotsky's description of the relationship of words and language with thought. Substituting drawing for words, Vygotsky says, "Thought is not merely expressed in [drawings], it comes into existence through them" (p. 218). This seems to be Goel's (1995) view, that in his research, design sketching, "played an important role in certain types of open-ended, explorative cognitive processes" (p. 218), different from mere problem solving. It is also consistent with McKim's (1980) understanding of the role of drawing in design, that "...drawing and thinking are frequently so simultaneous that the graphic image appears almost an organic extension of mental processes" (p. 11).

All this is dependent on the designer's ability to express (or illustrate) an idea in a variety of ways. "In both the exploratory and developmental mode, graphic ideators [e.g., designers] use many graphic idioms. When you are sketching from life or communicating a visual idea to others, you can be content with one graphic idiom. But when you are exploring ideas, you must use graphic language more flexibly..." (McKim, 1980, pp. 134–135). Verstijnen, et al (1998) observed the differences between skilled sketchers and unskilled sketchers, and concluded that the skilled sketchers benefited most from the visual representation in a sketch. When Lockard (1977) compared drawing to a language, he noted that, if the designer has a limited "vocabulary" of drawing skills, he will be plagued by "curious speech stoppages and deadly dull sentence structures..." (p. 111). He goes on to declare, "This vocabulary [of design drawing] needs to be expanded as does the vocabulary of any language that stays alive" (p. 111).

We live in a world, especially in academia, overshadowed by words. Lockard (1977) observed that, "Our cultural heritage is dominated by a linear, verbal, and 'rational' tradition

which can inhibit the use of drawing in design.” The implication of this tradition is a belief that decisions are made “rationally” (meaning verbally in the mind), and drawing is merely an act of the hand “printing” the decisions out. Instead, he argues for allowing the unconscious mind to contribute to the design process: “We are much older, and perhaps much wiser than our mathematical, verbal, ‘rational’ left frontal lobes, and drawing is one of the most natural and direct outlets for this rich and mysterious resource” (p. 111).

Design drawing as design language. One reason that design thinking and design drawing seem to be so similar is that drawing is very much like another closely related thinking activity: language. In fact, for most fields of design, we might agree with Archer (1992) who says that drawing is the language of design. Robbins (1994) also noted the similarity between drawing and language: “Because drawing is used to communicate ideas and to instruct others about a design, it is often seen as a language. Architects, when speaking about drawing, assume more often than not...that drawing may be construed to be a language or a quasi-linguistic order of communication” (pp. 27–28). Lockard (1977) says,

It is time we looked at drawing again, or perhaps for the first time, as a conscious activity, and a communicative language having, like any language, a syntactical structure. It is time we realized that the drawings we use, the order in which we choose to draw them, and our free, creative, confident use of, and continual, deliberate expansion of this language of drawing lie at the very base of any design method. (p. 106)

Tversky (2002) has identified several attributes of drawings that are language-like. “[Design drawings] are segmented into elements. They consist of language-like strings of stylized figures, lines, curves, and blobs. These elements can be combined in different ways to create different meanings, again, like language” (Schematic Structure section, ¶3).

Languages facilitate communication. Vygotsky (Vygotski & Kozulin, 1986) proposed that languages also facilitate thought. Simon (1996) identified some of the value of a design language to thought when he noted “By erecting such a hierarchy of concepts for himself, the designer is, after all, able to face the problem all at once. He achieves a powerful economy of thought, and can by this means thread his way through far more difficult problems than he could cope with otherwise” (p. 131). Languages in general provide advantages, particularly useful to design: (1) they allow thought to be communicated so that good ideas don’t get lost; (2) they provide a focus of attention which permits higher-power processing and anchoring of thought; and, (3) they provide the ability to question and judge the value of a thought—to construct thoughts about thought (Jackendoff, 1996). Schatz (2003) has suggested that for the field of ID to grow, it needs a design language to communicate what works and what doesn’t, as is the case in engineering. Gibbons and Rogers (2006) have argued for the need for more than one design language in order to express a design: “...many design languages already exist, and new design languages can be created that provide terms appropriate to the solution of sub-problems...” (Functional Design section, item #5, ¶1).

Stages in design and design drawing. Design takes place in stages, and changes in design drawing shadow these stages. The stages can be traced by observing to whom the drawing is intended to communicate, which is closely paralleled by the purposes for which they were drawn.

Designers in many fields often start their work with rough sketches to “try out” ideas before they commit them to more formal representations. “Engineers are notorious for not

being able to think without making ‘back-of-the-envelope’ sketches of rough ideas.

Sometimes these informal sketches serve to communicate a concept to a colleague, but more often, they just help the idea take shape on paper” (Ullman, Wood, & Craig, 1990).

As the design progresses to the latter purposes, the drawings become more formal, more governed by rules and conventions. Bucciarelli (1994) differentiated between the “hastily rendered sketch made to assist in the story telling of the moment” characteristic of early design, and the more formal “graphics, mechanical assembly drawings, circuit topographies, block diagrams, and charts” (p. 118) that exemplify the formal representations used for later purposes of design.

The more formal the drawing, the more commitment on the part of the designer is implied. For obvious reasons, it is better to catch a flaw or make a change at the sketching or drafting stage, or even after a formal design model has been made, than after the product has been produced.

Lockard (1977) organizes the stages of design by identifying the person for whom the communication at each stage is intended, in this manner:

1. self communication
2. interprofessional communication
3. client communication
4. builder communication
5. public communication.

(Because he is primarily writing for architects, Lockard uses the term “builder communication,” but any communication to any production person would fit the described stage.) Forms of communication, often design drawings, move through these stages as well.

The creative work of the designer starts with what Lockard (1977) calls “self-communication.” McKim (1980) ties self-communication directly to sketching and calls it “graphic ideation.”: “*Graphic ideation is visually talking to oneself; graphic communication is visually talking to others*” (p. 135, emphasis in original). He divides the first, graphic ideation, into two kinds of activity:

Graphic ideation has two basic modes: exploratory and developmental...

In the exploratory mode of graphic ideation, thinking and sketching are adventurous...Each sketch captures general features only, not details; it is a kind of rough map that allows you to return later to the concept, if you choose to develop it further.”

In the developmental mode of graphic ideation, you...develop a more thorough understanding of a promising concept.”

This division meshes with Lockard’s (1977) original idea of self-communication, where the first, exploratory drawings are analytical in nature to help the designer see broad patterns. Later, developmental drawings are held up for comparison to design determinants to become tentative detailed solutions to the problem. (p. 107). These two types of sketches are reflected in the two types of design cognition noted by Ulric Neisser, whom McKim (1980) quotes: “...all cognition consists of a two-stage act of construction: ‘the first is fast, crude, wholistic, [sic] and parallel, while the second is deliberate, attentive, detailed, and sequential’” (pp. 147–148).

The earlier, exploratory stage is most closely associated with Simon’s (1996) gap, mentioned above, in which design drawing serves as one bridge between the mind of the designer and the real world. McKim (1980) defines exploratory drawing as, “a means of probing [the designer’s own] imagination, seeking to touch and record the vague and elusive

imagery that usually accompanies the conception of a new idea” (p. 134). Verstijnen et al (1998, p. 520) point out that these exploratory idea-sketches have an important role in the creative process so often associated with design. It is to the exploratory process that McKim alludes when he says, “...drawing and thinking are frequently so simultaneous that the graphic image appears almost an organic extension of mental processes...Drawing not only helps to bring vague inner images into focus; it also provides a record of the advancing thought stream” (p. 11). Hanks and Belliston (1977) seem to be referring to exploratory design drawing when they say, “Since ideas and mental images are foggy, fleeting, and incomplete, it is imperative that they be captured and studied. Drawing is one way this can be done. Drawing allows you to bring the idea to life. It allows you to change, judge, and evaluate your thoughts” (p. 147).

In the later, developmental drawing, by contrast, the idea evolves through its embryonic concept into a mature form by repetition and refinement. McKim (1980) says “Developmental sketching is less schematic and more concerned with concrete details” (p. 135). The developmental phase is described by Arnheim (1995) as “a series of approximations, each one incorporating more relevant information and evolving until the final form emerges” (p. 71). McKim notes the memory-supporting facility of design drawing in his description of the developmental stage: “Further, drawing provides a capability that memory cannot: the most brilliant imager cannot compare a number of images, side by side in memory, as one can compare a wall of tacked-up idea-sketches” (p. 11). In fact, this developmental stage is where design may begin to be shared with other designers as per Lockard’s second recipient-based stage: inter-professional communication.

As these drawings progress, they become less free and more formal, less vague and more concrete. At some point the drawings cease to be clarifications, and become proposals: attempts to convince or persuade others of their value. It is at this point that they move to the third stage of communication and beyond: client communication, builder communication, and public communication. “[A]ll further drawings become a persuasive device, ‘commercials,’ to inform and persuade [the designer’s] professional associates, his client, builder and the general public that his design is the correct, reasonable, and beautiful solution to the problem” (Lockard, 1977, p. 107). Once the client has been convinced (which Lockard says comes by compromise and negotiation) the design is “set” and the drawing “finished.” The design drawings are used to communicate with builders (Robbins & Cullinan, 1994). The design has crystallized or “hardened” where it is unlikely to see major change. Finally, it may be used to communicate directly with the public. Robbins (1994) says that, for an architect, this form of design drawing often takes place after the building is built!

Later forms serve as the long-term memory of the design. Unfortunately, the earlier rough sketches “rarely survive for future generations to inspect” (Bucciarelli, 1994, p. 118). This is unfortunate because, as Lockard (1977) observes, that the importance value of design drawings to the creative aspect of design dwindles as the drawing becomes more refined. In a book for aiding architects and designers he laments,

In surveying the drawings I have used to illustrate my ideas I find that they are all rather stiff, studied works... I have never habitually saved the first rough sketches precisely because they are only a means—their only value being an interim visual statement toward a final real building... Except for the need to communicate the architectural idea more formally to other

people, the purpose of drawing the space is fulfilled with these little sketches.
(p. 36)

Up to this point, we have used Lockard's stages to discuss stages in design and design drawing. These stages use the recipient of communication to identify the stages of design and design drawing. It will be my approach that the progression from stage one to two, from two to three, and so forth, are often indicated by a change in purpose, as much as a change in recipient. These changes in purpose do not map perfectly onto the changes in recipient, but clearly show the same progression.

1. ideation,
2. negotiation,
3. persuasion,
4. crystallization, and
5. dissemination.

Both design and design drawing occur in stages that represent the recipients of communications, and also the purposes of communication. Lockard points out that the movement among these is not strictly linear. More often than not, the designer will cycle through previous stages as the design takes form and shape. Earlier stages are gradually abandoned in these cycles as negotiation and persuasion are accomplished; the design crystallizes and the sketches become means of dissemination. The sketches become increasingly formal and set, more useful as communication than ideation as they do.

Categorizing design drawings by form. Design drawings may be categorized by their form, that is, their shape, as well as the purposes for which they are drawn. Four examinations of form are reviewed and the list of groupings described by the chapters in a book by Laseau's (1986) serve as the best characterization of a taxonomy of design drawings

in the early, abstract stages of design. To this is added a category for representational graphics (after Massironi, 2002) to serve as a taxonomy of design graphics by form.

Figure 2.2 in a earlier in this chapter showed how ideas in the form of a bubble diagram progress through stages to become a rough architectural plan. Development from that stage to a complete blueprint is not difficult to imagine. Concrete, and even fully representational drawings may begin their existence as loosely-drawn, abstract forms. Simon (1996) observed that,

An early step toward understanding any set of phenomena is to learn what kinds of things there are in the set—to develop a taxonomy. This step has not yet been taken with respect to representations. We have only a sketchy and incomplete knowledge of the significance of the differences. (p. 133)

This section will examine different kinds of abstract design drawings to formulate the beginnings of a taxonomy.

Massironi (2002) has specifically attempted to create a taxonomy to classify and identify various kinds of graphic representations. (See Figure 2.8.). When considering design drawings, Massironi's most helpful contribution is his division between representational and non-representational figures—the two heavy horizontal lines in Figure 2.8. Many design drawings represent a physical reality, others are used to illustrate abstract concepts. As we have seen in Figure 2.2, the one may develop into the other. Note that Massironi's chart illustrates this concept by including several types of drawing that lie between the two and are connected to both.

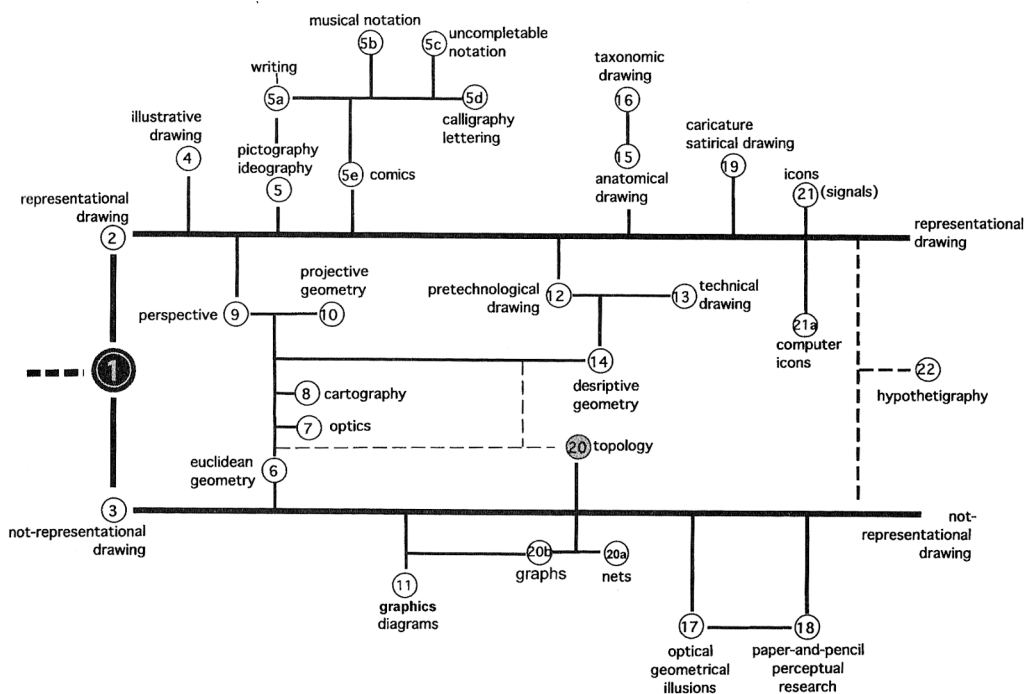

Figure 2.8. A taxonomy of graphic productions.

Note. From *The psychology of graphic images : seeing, drawing, communicating* (p. 3), by M. Massironi, 2002, Mahwah, NJ: L. Erlbaum. Copyright 2002 by Lawrence Erlbaum Associates, Inc.

Hansen (1999) proposes a basic abstract drawing language built from the symbols found in Figure 2.9. A quick review of these symbols will reveal that many of them are common sense (such as using lines to separate or connect, and squares as containers). Hansen provides the primitives (the “words” or symbols) and only hints about the “grammar” that would allow their combination into meaningful expressions. In this simple illustration, Figure 2.9, Hansen has captured many of the important elements and ideas of the abstract side of design drawing.

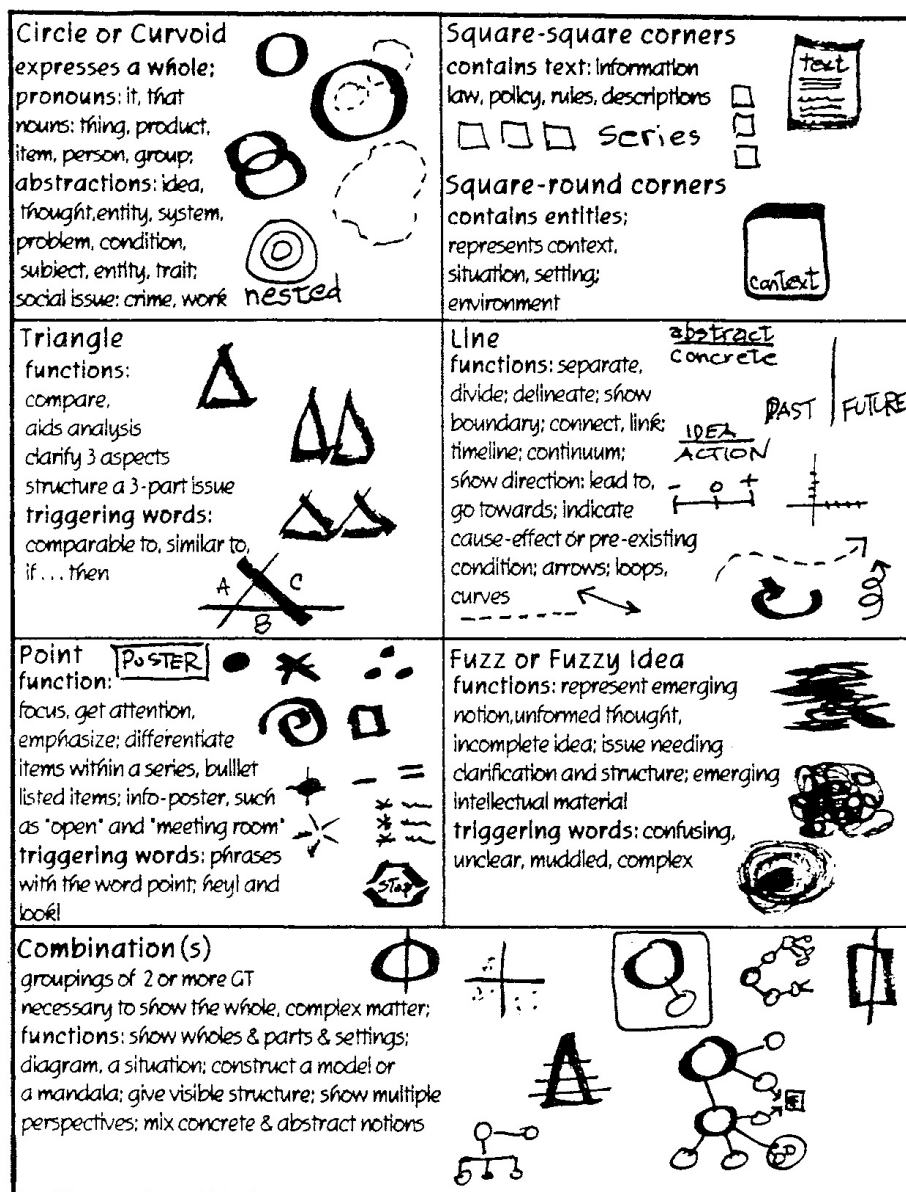

Figure 2.9. Hansen's "Graphic Tools."

Note. From "Visualization for Thinking, Planning, and Problem Solving," by Y. Hansen, 1999, *Information Design*, 193-220. Copyright by MIT Press.

In Chapter 21 of his book *Thinking Visually*, McKim (1980) provides common examples of what he terms *abstract graphic languages*. While McKim did not set out to build a taxonomy, his set of examples is valuable because the types of diagrams he includes specifically serve design and planning, at the same time giving designers ideas of where and

how to use them. Though the types identified are very specific, his treatment of them is liberal enough to include instances that may lie on the periphery of each type. He does not imply that the list is in any way complete; on the contrary, you get the idea that this is just a sampler. His list includes the following types of abstract graphic languages:

1. Venn diagrams
2. Organization charts
3. Flow charts
4. Link-node diagrams
5. Bar charts and graphs
6. Schematic diagrams
7. Pattern languages (As per Alexander, 1979)

In a similar, book-length treatment, *Graphic problem solving for architects and designers*, Laseau (1986) condenses all types of abstract design graphics into four basic groups. These groups are inclusive of McKim's abstract graphic languages. Each of Laseau's categories is covered by a chapter, with lots of examples.

1. *Bubble diagrams*. Squares, circles and other shapes ("bubbles") are containers for concepts; lines and arrows between them as well as their overlap represent relationships among the bubbles. Organization charts and flow charts are examples of these.
2. *Area diagrams*. Like bubble diagrams, drawn shapes are containers, but in this case the area of the bubble is representative of some kind of size or importance. Venn diagrams are the most obvious of these, but bar charts and graphs also exhibit characteristics of this type.
3. *Matrices*. In a matrix, the horizontal and vertical positioning of elements represents meaning. It is a way to show complex relationships in two or more dimensions. Schematic diagrams are occasionally of this type, as are graphs and tables. A text outline may be a type of matrix.
4. *Networks*. Networks are essentially bubble diagrams where the arrows and lines take on more importance than the bubbles, forming complex maps

of lines showing relationships. Link-node diagrams are clearly of this type, though organization charts and flow charts may also be.

The value of the list of Laseau's chapters, as summarized above, is that it includes the various forms of abstract representation (such as all of McKim's abstract graphic languages) and groups them into understandable categories according to common characteristics. If we add an item for concrete or representational graphics as well, (from Massironi's first division) Laseau's list a good, basic system for organizing design graphics by form. (Later on in this study, I use this modified Laseau's list to categorize design graphics.)

Value of vagueness in sketching. One of the advantages to abstract forms of representation is their ability to portray an appropriate level of ambiguity or vagueness—at least until the design has crystallized. The drawing must represent the current level of refinement, but not more. The sketch notates decisions made, while leaving ambiguous those areas of the design where decisions have not yet been made, leaving the door open for further refinement. Arnheim (1995) goes so far as to say that such a sketch, "...shows [its] vagueness with a desirable precision" (p. 72). This vagueness and ambiguity, according to Bucciarelli, (1994) not only enables design, but it is the very essence of design:

...a healthy measure of ambiguity and uncertainty makes room for designing...Participants envision and construe the uncertain as options, but behind the mask, the unknown lies waiting—and that too, is valued by participants. Uncertainty is what gives life to the design process and makes it the challenge that it is. If the process lacks uncertainty, then you can be sure it is not designing but copying. (p. 177)

Tang and Vero (2001) empirically confirmed the importance of vagueness in design representations. They observed that,

...a depiction has more than one meaning graphically and semantically after being created. It carries groups of meanings and relationships. Designers

utilize this characteristic to generate different concepts and to reason about functional issues through sketches. Consequently, sketches become affordances of meanings in the design process. (p. 279)

These “affordances of meaning” make it possible that, even though sketches are made with certain ideas and goals in mind, designers may fortuitously “...see new objects and configurations in their sketches. These encounters produce welcome but unintended discoveries, and may be a fruitful source of new design ideas” (Tversky, 2002, Why Do People Sketch section, ¶2).

Arnheim believes the vagueness of the sketch accurately reflects the ambiguity in the related mental image. He casts this vagueness as a plus, because,

...it has the positive quality of a topological shape. As distinguished from geometrical shapes, a topological shape stands for a whole range of possibilities without being tangibly committed to any one of them. Being undefined in its specifics, it admits distortions and deviations...This same vagueness is frequently apparent in the designer’s sketches. (p. 71-72)

Design as ill-defined problems. This ambiguousness in both the sketch and the mental image reflect the way designers tend to think about design problems in general. From the earliest cognitive studies of design (Eastman, 1969), to the present, design has been thought of as a process of solving ill-defined problems. Cross (2001) declares, “It is widely accepted that design ‘problems’ can only be regarded as a version of ill-defined problems” (p. 81). (Design has also been called a *wicked problem*, Rittel & Webber, 1973, which is an expansion of the term ill-defined.)

Though an ill-defined problem is described in various ways (Newell & Simon, 1972; Reitman, 1965; Zimring & Craig, 2001), what most definitions have in common is they have “variable problem spaces” (Zimring & Craig, 2001) meaning that these problems

require constant restructuring to arrive at a solution. Unlike well-defined problems, where the solutions can be obtained by reduction, transformation, or optimization of the data in the requirements (Archer & Roberts, 1992), ill-defined problems resist these systematic approaches to being solved, or are at least approached as though that were the case. In ill-defined problems, both the problem *and* the solution are moving targets; solution and problem co-evolve in relation to each other (Dorst & Cross, 1996).

This is interesting in light of what Simon (1996) says about solutions to problems being found in their representations of whatever form:

All mathematics exhibits in its conclusions only what is already implicit in its premises... Hence all mathematical derivation can be viewed simply as change in representation, making evident what was previously true but obscure.

This view can be extended to all problem solving—solving a problem simply means representing it so as to make the solution transparent. If the problem solving could actually be organized in these terms, the issue of representation would indeed become central. But even if it cannot—if this is too exaggerated a view—a deeper understanding of how representations are created and how they contribute to the solution of problems will be come an essential component in the future theory of design. (p. 132)

Simon's speculation certainly seems to hold true for well-defined problems like those of mathematics, but what if the problems are ill-defined, like design problems are characterized to be? What would then appear to be needed is a mode of representation that is capable of leaving undefined those portions of the design concept that have yet to crystallize while at the same time representing clearly what has crystallized. Sketching in the hands of a skilled designer would seem to meet this requirement.

Another aspect of ill-defined problems and design is that designers, especially expert ones, tend to treat all problems as though they were ill-defined, even when those problems

are well enough defined that they might reasonably respond to analysis. Cross (2001) observed that “designers will be designers, even when they could be problem solvers” (p. 82). That is, they tend to approach all problems as though they were ill-defined, as though the problem was as negotiable as the solution. More specifically, designers tend to start off quickly with proposed solutions, however rough they may be, and refine them as they proceed, rather than analyzing the data thoroughly in order to formulate a solution:

Many studies suggest that designers move rapidly to early solution conjectures, and use these conjectures as a way of exploring and defining problem-and-solution together. This is not a strategy employed by all problem-solvers, many of whom attempt to define or understand the problem fully before making solution attempts. This difference was observed by Lawson (1979), in his experiments on problem solving behavior in which he compared scientists with architects: ‘...[The scientists] operated what might be called a problem-focusing strategy... architects by contrast adopted a solution-focusing strategy.’ (p. 83)

In many cases design representations—usually sketches—fill the role Simon suggests, to make the solution transparent. According to Lockard (1977),

In the design process, we need to display tentative design proposals which we can continually compare to the restated design problem. These graphic representations will suggest restatements of the problem, and those restatements will in turn suggest more drawings. (p. 10)

Then, it is back to the drawing board (literally!) to modify the proposed sketch to reflect a new understanding of the problem and the solution—in a repeating cycle that results in constantly more refined drawings, and problems. This cycle between what is and what should or could be, as it applies to the representations, has been referred to as “the dialectic of sketching” (Goldschmidt, 1991).

The dialectic of sketching. In her much-cited study about the dialectic of sketching, Goldschmidt (1991) first breaks down design thinking into observable units which she calls

“movements.” She observed that progress in the design alternated between one kind of seeing to another and back again through these movements. These two kinds of seeing each support a different type of thinking. One type is analog or metaphorical thought which deals with seeing new meanings in the sketch. She calls this *seeing as*. Creativity is provoked in this reinterpreting of the sketch. The other type of thinking deals with the consequences of the newly perceived meanings—of judgment—which Goldschmidt called *seeing that*.

The importance of Goldschmidt’s study is that she observed empirically a phenomenon which has been proposed by others in theory or self-reporting (See, for example, Lockard, 1977; and McKim, 1980). Verstijnen et al. (1998), also observed a dialog, between combining and restructuring of concepts which could be viewed as virtually the same dialectic from a different perspective.

It is Arnheim’s (1995) opinion that without drawing, the dialectic that Goldschmidt observed does not happen; and without the dialectic, design does not happen; ergo, drawing is essential to design.

Drawing & narrative. As important as drawing may be to the design process, it rarely stands alone. Design drawings are nearly always accompanied by narrative, which supplements and adds meaning to the image. Bruner (2003) has stated, “We organize our experience and our memory of human happenings mainly in the form of narrative—stories, excuses, myths, reasons for doing and not doing, and so on” (p. 44). Visual representations, on the other hand, “...can render phenomena, relationships, and ideas visible, allowing patterns to emerge from apparent disorder to become detectable, and available, to our senses

and intellect” (Hansen, 1999, p. 198). The two, together, are better at communicating than either is alone.

McCloud (1993) has observed that while, historically, pictures and words have become separate entities in modern culture, they actually exist together in a larger continuum. He argues that it is their natural state to be mixed together (as indicated in the name of the Kindergarten activity, “Show and Tell.”) He elaborates, “Words and pictures are like partners in a dance and each one takes turns leading... When these partners each know their roles and support each other strengths...” (p. 156) they are powerful.

Bucciarelli (1994) observed the important relationship between narrative and drawing:

Drawings...show the characteristics displayed in narratives and, indeed, are themselves *essential to narrative* [emphasis added]. They show hierarchy, are abstract, bounded, measured, and so on. These are not just characteristics of the formal drawings stored and saved for posterity,...but they also structure the hastily rendered sketch made to assist in the story telling of the moment. (p. 118)

Schön’s (1987) protocol studies of architectural students makes visible the kind of dialogue that occurs between designers and their designs (as well as among designers). These dialogues show that neither the narratives nor the design drawings would be completely comprehensible without the other. Another example can be found in motion pictures’ use of narrative and the storyboard. A storyboard is nearly always accompanied (at a minimum) by snippets of the script written under the drawings, or in some cases, full impromptu performances used to complete the conveyance of the information in the drawings as seen in Figure 2.10 (See also Hart, 1999).



Figure 2.10. A storyboard being presented by a story artist.

Note. From *Disney animation : the illusion of life* (p. 194) by F. Thomas & O. Johnston, 1981, New York, N.Y.: Abbeville Press. Copyright 1981 by Walt Disney Productions.

The narrative associated with design drawing may be text found in the diagram itself (such as labels in boxes, etc.), it may be written nearby (as captions or explanations) or it may be from spoken words (in performance). Regardless of their relative location, words and stories—narrative—often accompany design sketches. These narratives complete and supplement the design drawings, and are, in fact, essential parts of fulfilling the purposes of design drawings.

Drawing as a catalyst for social agreement/commitment. One thing that makes the combination of words and graphics powerful is their ability to engage others in the act of design. Some have romanticized design in to a solitary act, shared only after it is perfected by the designer (Lockard, 1977). But, as already noted, design and design sketches go through stages of negotiation and persuasion with others: other designers, clients, patrons, builders, collaborators, etc. If they are focused on common goals and outcomes, drawing serves as an

important catalyst to draw these people together, or at least give them a common focus of discussion.

Bucciarelli's (1994) ethnographic study of design engineering situations observed that, "Despite differences among individual interpretations and constructions ... participants do communicate, negotiate, and compromise; in short, they design" (p. 81). Later, he concludes,

'Shared vision' is the key phrase: The design is the shared vision, and the shared vision is the design. Some of this shared vision is made explicit in documents, texts, and artifact—in formal assembly and detail drawings, operation and service manuals, contractual disclaimers, production schedules, marketing copy, test plans, parts lists, procurement orders, mock-ups, and prototypes.... The shared vision, as some synthetic representation of the artifact as a whole, is not in the documents or written plans. To the extent that it exists as a whole, it is a social construction—dynamic, plastic, given nuance and new meaning at each information gathering of two and three in a hallway or at formal meetings such as scheduled design reviews. (p. 159)

As he notes in another place, "The final chart is hardly interesting, and rarely referred to, unless it later shows a bug or is challenged by further developments. But if that happens, the negotiation process starts anew" (p. 189).

This view is reflected by Robbins (1994) where he says, "Drawing and the worlds it represents are a product of social and cultural agreements among architects and others" (p. 29). In another place, he observes that drawing is a source of commitment among participants to the design.

Final design drawings and documentation serve as the long-term memory of the design and show commitment. These documents are required to stand on their own in spite of the fact that only those who participated in the negotiation that resulted in this design will be able to derive the full context and meaning from them. They become reference works to

which the designers and producers refer. Formalization and crystallization are intended to strengthen and solidify the documents as tools of communication, but it requires careful skill to weave the meaning into these reductions in order for them to convey that meaning through the artifact.

Summary of Research on Design Drawing in Design Studies

In summary, it was observed that designers accomplish their work by means of design representations, of which design drawing is a principal type. Examples of design representations from various fields of design were examined.

Design drawing has been a subject of great interest in the field of design methodology. Design drawing's close association with thinking and its very language-like attributes were discussed. It was further observed that design drawing reflects the stages of design to which they belong. These stages are characterized by both the recipients of design communications (usually design drawings) and by the purposes for which they are drawn. Drawings may also be categorized by their form, and candidates for taxonomy were reviewed and one selected and adapted for that purpose. Several authors noted the seemingly paradoxical value in vagueness or ambiguity in design drawings, which may be related to the idea that most design problems are seen as ill-defined. The value of vagueness in design drawings, and the belief that design problems are usually treated as if they were ill-defined, cause them to be approached in cycles or vacillations. These cycles are referred to as a dialectic of sketching which is considered by some authors to be vital to the design process. It was also noted that design drawings rarely stand alone, but are usually accompanied by a narrative. The narrative and drawings complement each other's ability to convey meaning.

Lastly, it was recognized that as designs crystallize and design drawings reflect that crystallization, the drawings become an important catalyst for evoking social agreement and commitment—vital because design may be defined as “shared vision.”

This review of the many uses and roles of design drawing in the literature of design methodology demonstrates the depth of interest that this topic has generated in that literature. This, in turn, will help highlight the contrast between the interest shown to design drawing in design fields other than ID, and the interest seen in design drawing in ID.

Evidences of Design Drawing in ID

The experience of many instructional designers strongly suggests that design drawing is a part of ID as well. However, this review of the literature of ID will show that ID does not appear to have the same tradition for design drawing, especially during the early phases of design, as is found in other design fields. For this review, evidence or examples of design drawing in ID was sought in several sources: ID textbooks, journals, software, and case studies were all examined. The ID literature for research about design drawing in ID was also searched. With some notable exceptions, very little was found.

To facilitate the study of design graphics, I created a typology of graphics found in ID literature. This section describes this typology as a means to categorize graphics of interest to this study. Gibbon’s instructional design layers are then used to further sub-categorize one of the types of graphics found in the literature.

A Typology of Images

A variety of types of illustrations can be found in the literature of ID. Some are design graphics and are closely related to the subject of this study, but many are not. To aid

in distinguishing those that are, this typology of images has been devised. A sampling of the literature of ID was scanned for graphics, and then those graphics found were categorized into one of five types based on their apparent intent.

- Type 1: *Design graphics*. Design graphics illustrate some aspect of the design of a specific piece of instruction for the purpose of planning or building that instruction. This is the kind referred to almost exclusively in the previous section of this literature review and are most closely related to the subject of this study
- Type 2: *Content graphics*. Content graphics are part of the instruction delivered to learners that aid or support learning.
- Type 3: *Reporting graphics*. These graphics are used to illustrate or report the outcomes of research.
- Type 4: *Illustrations of ID models*. Graphics of this sort are illustrations that represent processes of design or construction of instruction. Diagrams of the popular ADDIE or ISD processes fall into this category.
- Type 5: *Instructional models & learning models*. These graphics include illustrations of the components of instructional theories or learning theories and the relationships among them. They are sometimes not differentiated from ID models (type 4).

The principal difference among these types is intent; the surface form may not be the discriminator. For example, it is possible to imagine a graphic, whose intent is unclear without the accompanying explanation because the drawing is too vague.

Let's examine each of these different types of graphics found in the research literature.

Figure 2.11 is an example of a type 1 graphic. It is clearly related to some specific piece of instruction, charting the flow of procedures for training a specific piece of content. It

may have been created to help a programmer or developer understand what was supposed to happen in this instruction.

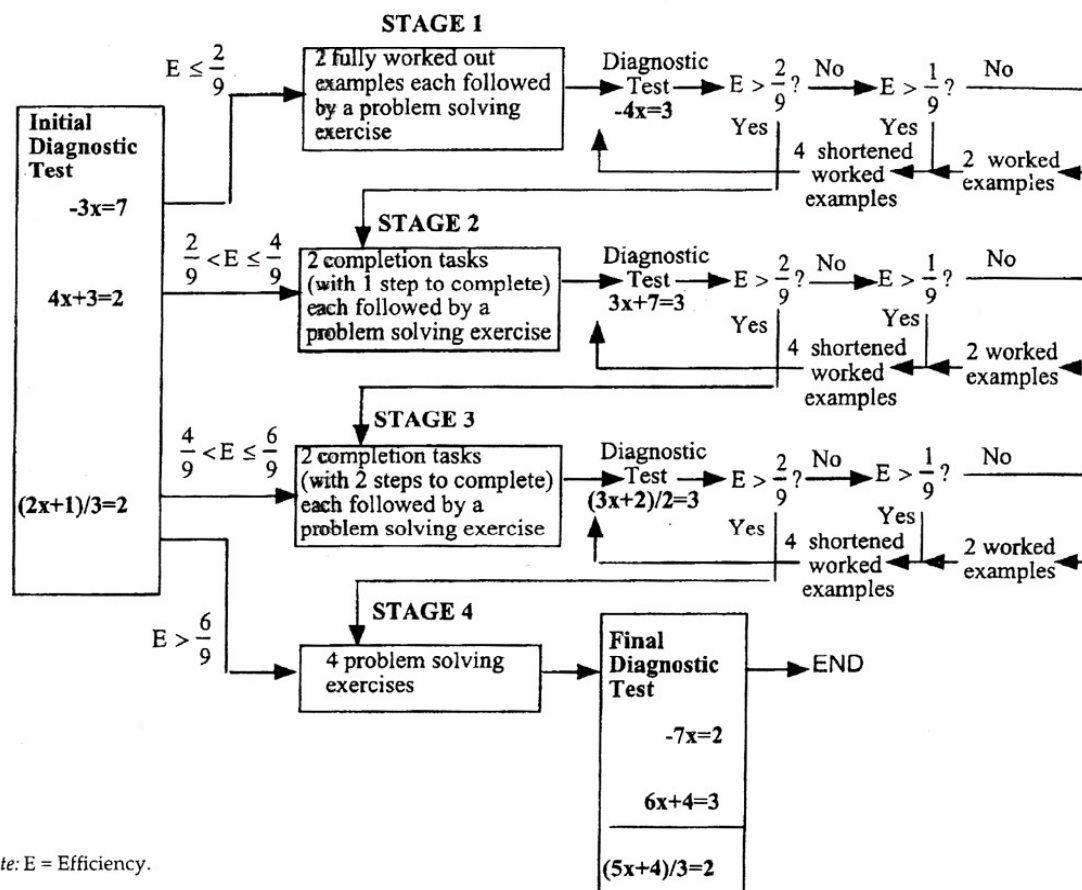

Figure 2.11. An example of a type 1 graphic from ETR&D. Notice the specific content in the graphic.

Note. From "Rapid dynamic assesment of expertise to improve the efficiency of adaptive e-learning," by S. Kalyuga, & J. Sweller, 2005, *Educational Technology Research and Development*, 53(3), pp. 83–93.

Type 1 graphics have information, either in the diagram or in the accompanying context, that ties them directly and clearly to the design of a specific piece of instruction. They may refer to specific content, as does Figure 2.11. They illustrate the structural elements, flow, process, information chunking, or some other aspect of the specific

instructional design. To determine if a graphic is of type 1, ask, “Was this graphic representation created to assist in the creation of specific instruction?”

Type 2 illustrations are distinguished from type 1 by being part of the content of the instruction, rather than part of the design. That is, they are presented to the learner. Figure 2.12 was part of the content of experimental instruction trying to determine the difference in value between using mimetic icons versus standard square icons in a content graphic.

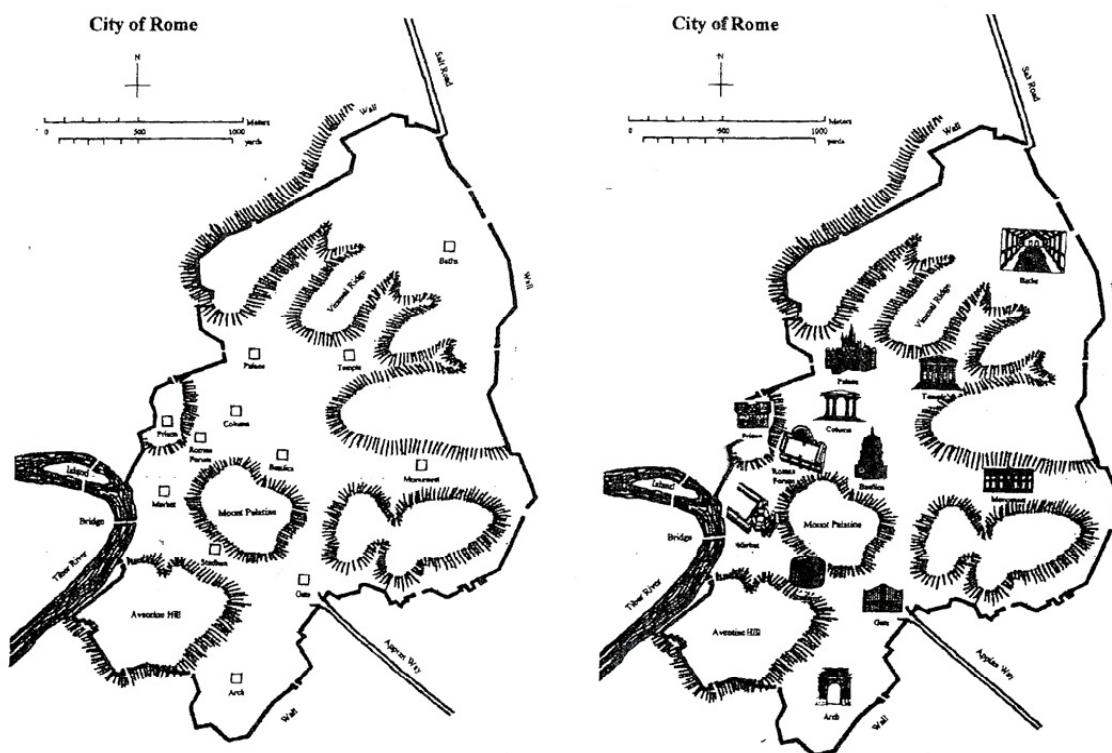

Figure 2.12. An example of two type 2 graphics from ETR&D.

Note. From “Does spatial or visual information in maps facilitate text recall? Reconsidering conjoint retention hypothesis,” by M. M. Griffin & D. H. Robinson, 2005, *Educational Technology Research and Development*, 53(1), 23–36.

Computer screen shots of finished Computer Assisted Instruction (CAI) are common illustrations in the sources reviewed. These screen shots should be considered type 2. To

decide if something is type 2, ask, “Was this graphic representation part of what was presented to learners during instruction?”

Type 3 graphics are used illustrate the outcomes of research. They are often employed to help make statistical results more transparent to the reader. Bar graphs, pie charts, line graphs, etc., are common, though they are not limited to these. They are distinguished from type 1 because they illustrate the results of evaluation or research rather than the proposed design of a piece of instruction. Figure 2.13 is a typical example of type 3 graphic which supports a report on outcomes of research.

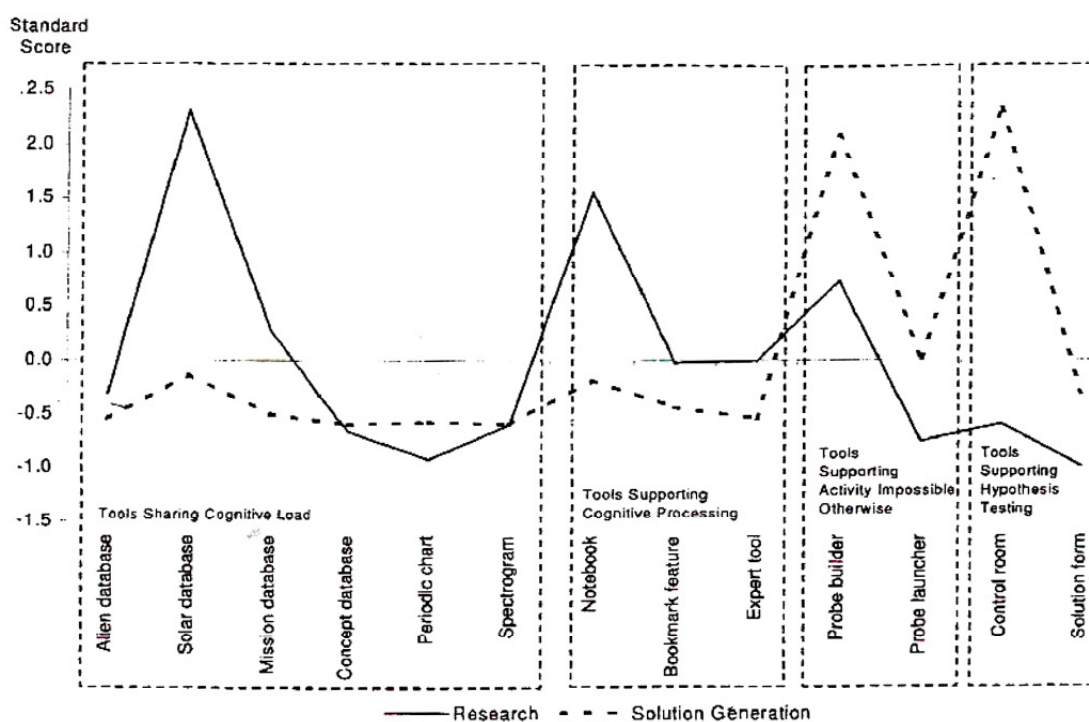

Figure 2.13. An example of a type 3 graphic from ETR&D.

Note. From “An analysis of cognitive tool use patterns in a hypermedia learning environment,” by M. Liu, & S. Bera, 2005, *Educational Technology Research and Development*, 53(1), pp. 5–21.

To determine whether a graphic representation belongs to type 3, ask, “Does this graphic help report the results data or other outcome of the evaluation or research?”

Type 4 diagrams are used to illustrate models of design processes, what Reigeluth calls an “instructional-design process.” (p. 13). Figure 2.14 shows Dick and Carey’s model for the systematic design of instruction—a classic example of an illustration for a design process. The purpose of type 4 graphics is to help the reader understand a design process model, i.e., how to design or create instruction.

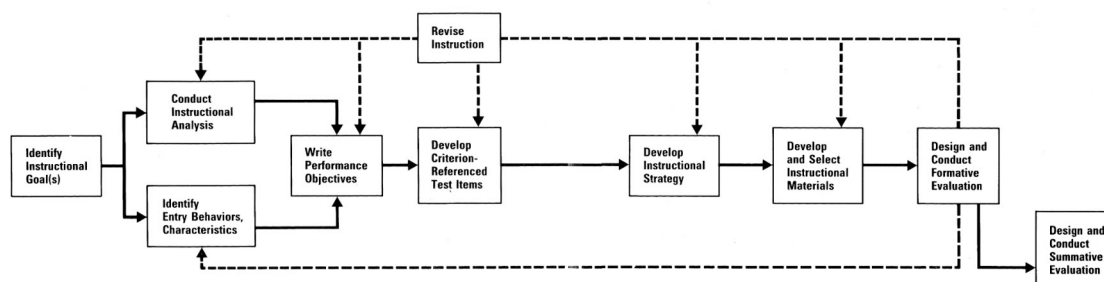

Figure 2.14. Dick and Carey’s model for “Systematic design of instruction” as an example of a type 4, design process diagram.

Note. Adapted from *The systematic design of instruction* (3rd ed.) (pp. 2-3), by W. Dick, & L. Carey, 1990, Glenview, IL: Scott, Foresman/Little, Brown Higher Education. Copyright 1990 by Walter Dick and Lou Carey. Copyright 1985, 1978 by Scott, Foresman and Company.

To clarify whether a diagram belongs to type 4, ask, “Does this graphic illustrate a design process or theory about how instruction ought to be designed?”

Finally, type 5 diagrams illustrate instructional models and learning models. Figure 2.15 is an example of a type 5 diagram. Note that it describes or illustrates a general principle of teaching or learning and is not specific to a particular piece of instruction nor does it describe a process by which instruction is created. This type of diagram would normally be illustrating an instructional theory or learning theory.

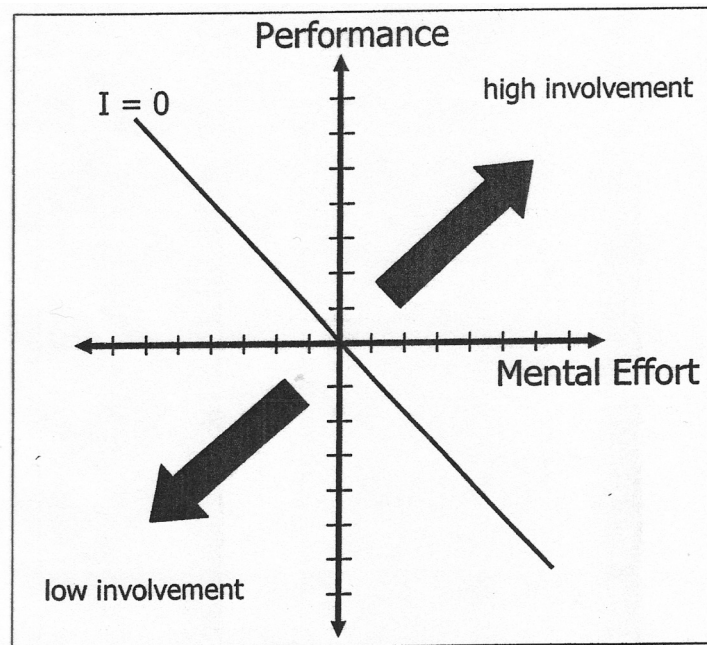

Figure 2.15. An example of a type 5 graphic.

Note. From “A motivational perspective on the relation between mental effort and performance: optimizing learner involvement in instruction” by F. Paas, J. E. Tuovinen, J. J. G. van Merriënboer, and A. A. Darabi,” 2005, *Educational Technology Research & Development*.

Design theories and models (type 4) are often confused or conflated with learning and instructional theories and models (type 5). May (2006) distinguishes between design theories and learning or instructional theories by noting that design theories pertain to how someone designs an instructional product to achieve certain objectives, whereas learning theories pertain to how someone receives, processes, and remembers information. Though similar in some respects to type 4, design process model diagrams, type 5 diagrams can be distinguished from the others by asking, “Does this graphic illustrate a theory of learning or a theory of instruction?”

While this typology covers the majority of illustrations one might expect in research about instructional design, other kinds of images occasionally occur. For example, a

photograph of the principal of a school where an intervention took place, is probably not easily placed into any of the types proposed.

Extending the Typology of Type 1 Design Graphics with ID Layers

Once graphics have been established as type 1, design graphics, is possible to extend the typology to identify and distinguish them from each other. This sub-level of categorization provides the ability to see how widely design drawings are used throughout the design process.

This sub-categorization is accomplished by adapting a concept put forth by Gibbons (2003) called *instructional design layers*. Gibbons has observed that instructional design often takes place as the design of several inter-related layers. Design of each layer can be considered separately from the other layers, providing an important modularization to the design effort. The design of each layer is expressed in design languages, and these languages define the scope of designers' thinking. Gibbons' instructional design layers are:

- content
- strategy
- control
- message
- representation
- media-logic
- data management

At the *content layer*, the designer defines the units of content segmentation, determines the method of content capture, and defines the kind of content elements that will be gathered. The design problem in the *strategy layer* consists of several inter-related sub-problems concerned with structures of time, goals, sequence, activity, physical setting, and social relationships are decided. The design problem within the *control layer* is the means of

communication of messages from the learner to the source of the learning. The *message layer* determines the types of instructional messages, how they are composed, and how they are generated. The *representation layer* is the selection of media types, the selection of media, its generation, and the rules governing its structure and display. The design problem within the *media-logic layer* involves the description of execution structures that enact the representation and interactions. The design problem at the *data management layer* is to plan the capture, storage, analysis, aggregation, interpretation, and reporting of data produced during instruction.

This typology and its extension to type 1 graphics by ID layers has been applied to a number of sources to discover and analyze examples of design drawing in ID. These sources are discussed below.

ID Literature Sampling

ID textbooks sampled. A sampling of common texts in the field of ID was searched for images. Images found were then filtered through the typology above to identify examples of design drawings, type 1, in the texts. The texts included in this review are common, well-known textbooks about instructional design. Included in this review are the following textbooks: *The systematic design of instruction* (Dick & Carey, 1990), *Principles of instructional design* (Gagné, Briggs, & Wager, 1992), and the two volumes of *Classic writings on instructional technology* (Ely & Plomp, 1996). An argument could be made to bring in other texts not included here, but these are an adequate representative sample for my purposes.

The original edition of Dick and Carey's book from the late 1970s is the source of the first "Dick and Carey model" of instructional design known to nearly every instructional

design student of the last thirty years. This model is particularly helpful to inexperienced or beginning instructional designers because it provides a complete systematic approach to the process of instructional design. (This review uses the 1990 edition of the text.)

The familiar blue and violet book by Gagné, Briggs, and Wager (1992) can be found on the bookshelf of nearly every instructional designer trained in the 1990s. Its presence on the bookshelves of colleagues often means that it was purchased as a class textbook, but it was kept for its ongoing value as a reference. This textbook provides a rational basis for much of the practice in instructional design, based in cognitive psychology and information processing theory.

The two-volume set from Ely and Plomp (1996) is a collection of classic literature in the field of ID. As such, it has value for both its historical reach, and the breadth of coverage. These volumes of classic articles reveal some of the roots of the field of instructional technology in audio/visual production and distribution, about which many of the papers are concerned.

ID journals sampled. For the purpose of this review, three respected ID journals were also scanned for graphics. Graphics found were categorized by the types above to discover any type 1, design graphics. The journals surveyed included: *Educational Technology Research and Development (ETR&D)*, *Interactive Learning Environments (ILE)* and the *Journal of Educational Technology Systems (JETS)*. It was felt that this combination of journals gave a sufficiently broad cross section of the field to effectively represent graphic communication in ID research literature.

ETRD is a bi-monthly research publication of the Association for Educational Communications and Technology (AECT). It contains sections on both research and development, as well as book reviews, international reviews, and research abstracts. AECT has a historical connection to schools and libraries (especially audio/visual departments) and has good relationship with the faculty and students from universities that have degrees in instructional technology. AECT is an international organization, but its roots are American, and the majority of its members are from the United States. Articles in *ETRD* tend to reflect this orientation. For this study I looked at all the graphics in volume 52 (2004), one full year.

ILE is an international journal about the impact of technologies (the Internet, groupware, multimedia, etc.) on education, training, and life-long learning. The journal includes articles that cover both tools and organizational support required for authoring and implementing courseware. *ILE* is published three times a year; one publication contains two volumes. I reviewed volume 12, numbers 1 and 2 (a single publication), volume 13, numbers 1 and 2 (also a single publication), and volume 13, number 3. This covers roughly a year and one third.

JETS is published by Society for Applied Learning Technology (SALT). This quarterly journal deals with systems in which technology and education interface with special emphasis given to the use of computers as a component of education systems. Members of SALT tend to come from the ranks of government and military, industry, and education, in that order. *JETS* reflects this priority in the types of articles it contains. For purposes of this study volume 33 (2004-5), covering one year, was reviewed.

Sample of design drawing in ID software. Since the early days of multiple slide projectors driven by cues on a sound track, multimedia has been explored as an instructional medium. Since the computerization of these tools, there have been graphic user interfaces among instructional multimedia authoring tools. PCV3 from Control Data and forms of visual PILOT (a computer-assisted instruction language; the acronym stands for Programmed Instruction, Learning, Or Teaching) and *Quest* from Allen Communication are examples of these. Of all these systems, *Authorware* enjoyed a unique position by being popular as a general-purpose multimedia authoring system as well as an instructional design solution, in spite of the fact that it was expressly developed to serve the needs of ID. Though they are very popular with instructional designers, Macromedia *Director* and *Flash*, are general-purpose multimedia authoring tools, and were mentioned previously. *Authorware* was selected for discussion in this section because it is by far the most popular ID-specific tool and it uses a graphic user interface that mimics traditional flowcharting familiar to instructional designers and others.

Samples of ID case studies. It may be argued that ID textbooks and journals would not be a fruitful source of ID graphics because they are mostly concerned with general theory and broad explanations. If that were true, then one particular kind of study would be more apt to provide evidence of design drawing in instructional design: case studies.

Indications that cases may be a fruitful source of examples of design drawing in ID can be found in a popular set of competencies for instructional designers called “Competencies and Skills for Instructional Designers” (Analysis & Technology, 1995) of this list of competencies suggests that instructional designers be competent in the ability to,

- Develop flowcharts to identify learning events at the frame specific level using standardized symbology
- Develop storyboards using a template appropriate to the needs of the project

Case studies may be found in journal articles, dissertations, and books. For purposes of this study, one book of ID case studies, plus five additional case studies were reviewed.

The book of ID case studies reviewed is *The ID casebook: case studies in instructional design* (Ertmer & Quinn, 2003) which is a compilation of 36 instructional design cases for use as practice by beginning instructional designers. Five additional case studies, four dissertations and one research article, were also reviewed. Most of the additional case studies were found by searching *Doctoral research in educational technology* (2005) as well as Digital Dissertations (University Microfilms) and ISI Web of Science (Institute for Scientific Information), searching for the term “case study” in the title of instructional design articles and dissertations. Case studies were considered that seemed to cover the instructional design of materials, rather than other cases (such as those about educational programs or processes), as it was thought that these would be the most productive sources of design drawing. The article is by Gastfriend, Gowan, and Lane (2001) and the dissertations include Ludwig-Hardman (2003), Hall (2004), and Twitchell (2001). Another dissertation, May (2006), was recommended by a colleague.

Samples of ID research literature with design drawing as a topic. Although drawing as a method of design has been discussed in general literature of design studies since the 1960s and before (Jones, 1970), it has only recently become the object of study in ID. Initially, the search for ID literature about design drawing was frustrating—particularly with automated search tools. Any attempt to combine terms like “drawing,” “graphic,” or “representation”

with “instructional design” or “instructional technology” invariably resulted in research titles that had to do with the use of visual media *in* designed materials (type 2), not *for* their design and development (type 1). However, by careful screening, a few studies were identified that seemed relevant. These are: some articles authored by Gilbert Paquette and others (Paquette, 1996; Paquette, Aubin, & Crevier, 1994; Paquette, de la Teja, Lundgren-Cayrol, Léonard, & Ruelland, 2002; Paquette, Léonard, Lundgren-Cayrol, Mihaila, & Gareau, 2006) about proposed graphic notation systems for ID; and, an article by Figl and Derntl (2006) which discuss Visual Instructional Design Languages (VIDL). One of the VIDLs discussed in Figl and Derntl is Botturi’s E²ML. I will also discuss Botturi’s (2003) dissertation on E²ML in detail.

Results of ID Literature Review

ID textbook results. For this literature review, three textbooks, Dick and Carey (1990), Gagné, Briggs, and Wager (1992), and Ely and Plomp (1996) were reviewed. All the graphics and illustrations in these textbooks were classified according to the typology discussed earlier into one of five types (or miscellaneous if they did not seem to fit any of the categories). This classification is presented in Table 2.1.

In two of the books, design drawings predominate, taking 42% in Dick and Carey (1990) and 62% in Gagné, Briggs, and Wager (1992). In Ely and Plomp (1996), design process model diagrams—type 4—lead, but with only 33% of the total. The difference in dominance of type 1 in first two books versus type 4 in last book can be explained by the differences in the purposes for which the books were written. The textbooks by Dick and Carey, and by Gagné, Briggs, and Wager are both intended as textbooks for the beginning

Table 2.1.

Types of Graphics Found in Three ID Textbooks

	Type 1 Design	Type 2 Content	Type 3 Report	Type 4 Process	Type 5 Instr'l	Misc
Dick & Carey	28	2	6	6	9	15
Gagné, Briggs & Wager	16	4	1	4	1	0
Ely & Plomp	2	7	4	12	4	7

designer. As such, they provide basic instructional design process information for guiding the novice instructional designer in her beginning work. This explains the prevalence of instructional design examples represented by these design drawings. Ely and Plomp, on the other hand, is a collection of miscellaneous papers from various sources brought together because of their seminal value to the field of ID. Because many of these papers propose instructional design models, the prevalence of type 4 model graphics should not surprise us.

The beginning of each chapter of Dick and Carey starts with a duplicate of the diagram of their model, with that chapter's step highlighted. Because the same diagram is repeated each time to aid in navigating the book, these model graphics were only counted once. Also, Dick and Carey contains a relatively large number of graphics categorized as "miscellaneous." Most of these miscellaneous graphics are depictions of proposed elements of their notation system for skills analysis. As such, they do not fit neatly into any of the categories.

The preponderance of design drawings or graphics in both Gagné, Briggs, and Wager, and in Dick and Carey was unexpected. Closer inspection of these graphics reveals

that nearly all of these type 1 design graphics occur in the first third of both books, and all of them are examples of skills analyses. Each book sets forth a slightly different notation system for illustrating the results of skills analysis.

Viewing the skills analysis drawings through Gibbons' (2003) instructional design layers, discussed earlier I found that all the type 1, design graphics, in Dick and Carey, and in Gagné, Briggs, and Wager, fall within the content layer. As such, they are an important use of design drawing in their own right, but represent only a small fraction of the potential uses of design drawing in ID.

In summary, examples of design graphics in these textbooks are common, but limited to only one of Gibbon's seven layers of instructional design: content. If design drawing itself were considered an important aspect of instructional design work by these authors, I would have expected to examples illustrating other of Gibbons' design layers represented in this sample literature. Interestingly, content or skills analysis is often used as the starting point for instructional design, so the use of graphic as an aid to the start of instruction is noted.

ID journal results. For this literature review, three ID journals were reviewed. They are *Interactive Learning Environments (ILE)*, *Educational Technology Research and Development (ETR&D)*, and the *Journal of Educational Technology Systems (JETS)*. All the graphics and illustrations in selected issues were classified according to the typology discussed earlier into one of five types. This classification is presented in Table 2.2.

The three journal titles that were sampled for this study show some variation from the results of the textbooks.

In these journals, many articles demonstrated or discussed specific instructional

Table 2.2.

Types of Graphics Found in Three ID Journals.

	Type 1 Design	Type 2 Content	Type 3 Report	Type 4 Process	Type 5 Instr'l	Misc
ILE	11	46	7	14	3	0
ETR&D	1	13	12	8	4	4
JETS	5	30	26	2	0	0

design projects. As a result, type 2 graphics (screen shots from instructional computer programs and other illustrations of content) predominated: in ILE 56%, in *ETR&D*, 31%, and in *JETS*, 48%.

In *ETR&D*, the balance between research and development articles is reflected in the balance between type 2, content graphics (31%), and type 3, report graphics (29%). *JETS* is similarly balanced between type 2 and type 3.

Type 1 graphics, while not the least common, are always in the minority. In *ETR&D* they were the smallest category, 2%; they are the third smallest category in both *ILE* at 14% and, in *JETS*, at 9%.

In summary, even more dramatically than in the textbooks analyzed, these numbers indicate the relatively light value placed on type 1, design graphics, in the journal literature of ID. Instead, we find a preponderance of type 2, content graphics, often, captured computer screens or graphics, used to illustrate reports about specific products.

ID authoring software results. *Authorware* is the ID multimedia authoring software reviewed in this study. The original *Authorware*, called *Course of Action*, was created by

programmer and instructional designer Michael Allen who had been working on Control Data's PLATO courseware. It was his intent to build a system that would require little or no programming to produce instructional courseware. (Wikipedia: Authorware)

To build a presentation in *Authorware*, the designer drags pre-defined behavior icons from a *palette* of behaviors onto a design window. Once in the *design window*, a behavior's specific attributes can be set. The behavior icons in the design window are connected into a visual flowchart called a *flowline*, which determines the sequence in which the behaviors are executed. Figure 2.16 shows several *design windows* with *flowlines* in them. Also note the palette of behaviors on the left side of the figure. Behaviors include *display*, *motion*, *erase*, *navigation*, *interaction*, *calculation*, *movie*, and others. The available behaviors have changed over the life of the product. When an *Authorware* presentation is executed, the behaviors play out their actions on the *presentation window* (not shown).

It is surprising that *Authorware* is one of the few ID products that uses a visual approach to design. The dragging of behaviors to the design window and connecting them into a flowline is a good example of a visual metaphor. *Authorware's* iconic, visual interface allows designers and authors to work more efficiently. The visual metaphor excels at providing the author the ability to see the flow of media-logic and to catch logical errors in thinking.

However, much of *Authorware's* functionality is not accessed visually, but by means of dialog boxes for specifying the attributes of behaviors and in other non-graphic ways, including a complete scripting language inside the application. Viewed through Gibbons' layers of ID we find that the flowline—the most graphic aspect of *Authorware*—is limited to

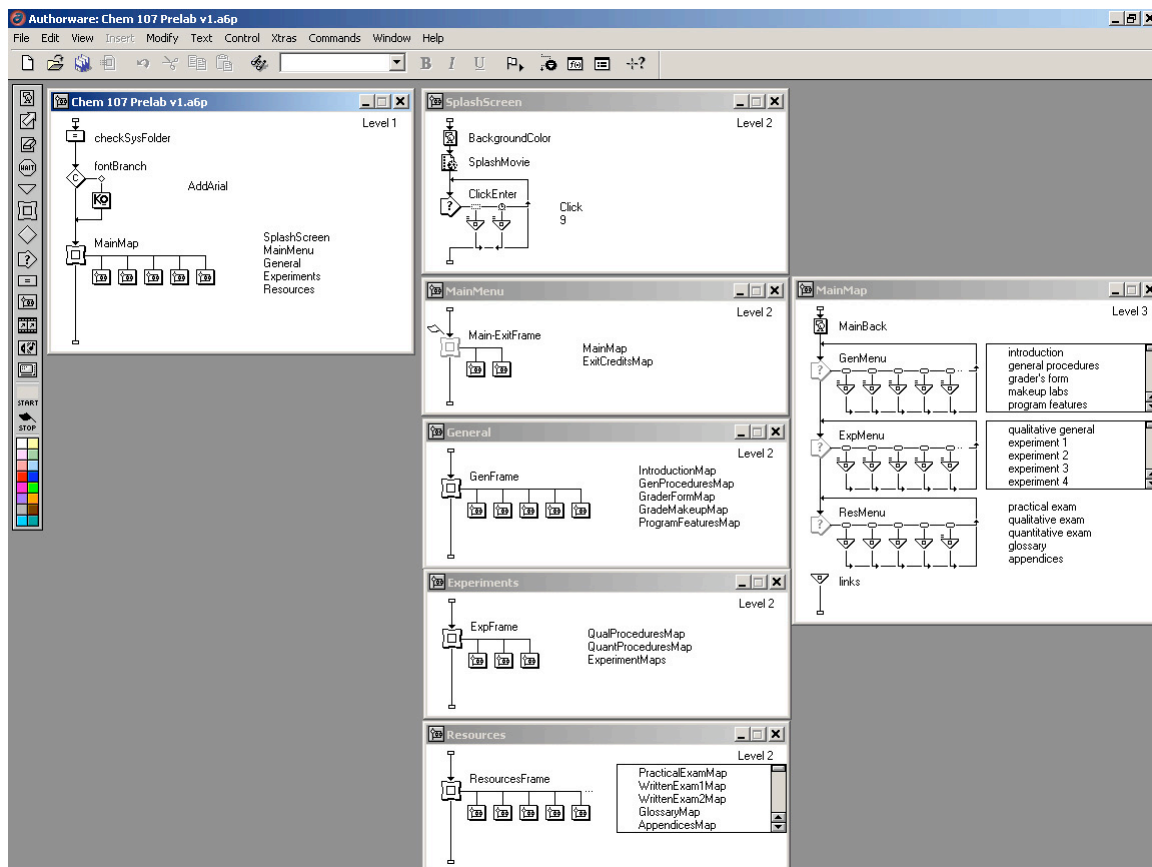

Figure 2.16. Authorware presentation's behavior palette (far left) and several flowlines.

Gibbons' strategy layer and media logic layer because it allows the designer to define the sequence of instructional events, and it directly affects the logic of execution. Visual means are also provided for composing the screen presented to users (the representation layer) but each screen must be composed separately—there is no way to compose families of screens through the visual interface (though it might be scripted in the scripting language). There are also ways to add control elements to the screen (addressing the control layer), but, except for their placement on the screen, the manipulation of these screen controls is not performed through the visual interface. *Authorware* does have some built in student tracking capability (supporting the data management layer), but more than basic functions of this capability

require scripting. *Authorware* has no provision for the content layer, or for the message layer to be addressed by the designer.

ID case study results. Of the six sources for case studies reviewed, only two illustrated significant examples of design drawing. In the other four, there was little or no evidence of type 1, design graphics (though several of them did have examples of types 4 and 5—graphics supporting instructional design process models and instructional or learning models).

The first source of ID case studies examined was Ertmer and Quinn's *The ID casebook: case studies in instructional design* (2003). Ertmer and Quinn contains only one illustration of type 1, shown in Figure 2.17. It is the results of a skills inventory for flight attendants. Like the design graphics found in the textbooks, it addresses Gibbons' content layer.

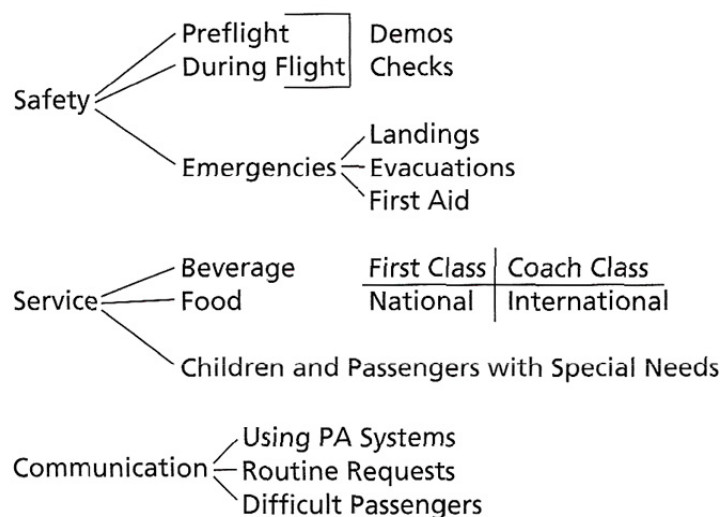

Figure 2.17. Simplified job map for level 1 flight attendants.

Note. From *The ID casebook: case studies in instructional design* (2nd ed.) (p. 68), by P. A. Ertmer, & J. Quinn, 2003, Upper Saddle River, NJ: Merrill. Copyright 2003, 1999 by Pearson Education, Inc.

Of the five additional case studies chosen, the research article (Gastfriend, Gowen, & Layne, 2001) and two of the dissertations (Hall, 2004; Ludwig-Hardman, 2003) contained no examples of design drawing at all.

The dissertation-case study by Twitchell (2001) contains in an appendix a copy of the design document for the courseware about which the case is written. Included in this design document are several instances of design drawings and representations. Here is a sampling:

- a.* A structural perspective: component parts (a Vehn-diagram-like illustration, with a circle and squares representing instructional components), p. 199.
- b.* A data-flow diagram, p. 200.
- c.* A logic & data-flow diagram, p. 202.
- d.* Several tables containing important data.
- e.* A rough screen shot of the initial screen, p. 214.
- f.* Several other rough (wire-frame?) screen shots, pp. 10, 11.
- g.* A flowchart of instructional logic for a drill, p. 234.
- h.* The instructional flow of the program, p. 237. (see Figure 2.18)
- i.* A screen shot (more refined than previous screen shots, but still not final) + Pull-down menu items, p. 240.
- j.* Additional screen shots, pp. 242, 244, 245, 247, and 249.

These figures comprise a fairly broad representation Gibbons' ID layers. For example, the rough screen shots (items *e*, *f*, *i*, and *j*) are intended to guide the developer in the production of user-interface screens. As such they are clearly illustrative of the representation layer in the abstract, but probably also contain elements of the content and

message layers as well. Item *a* is a broad view of the strategy layer as it applies to the entire piece of courseware; *g* is an example of a narrow view of one component of the courseware at the strategy layer. Item *h*, shown in Figure 2.18, illustrates aspects of both the strategy layer as well as the media-logic layer.

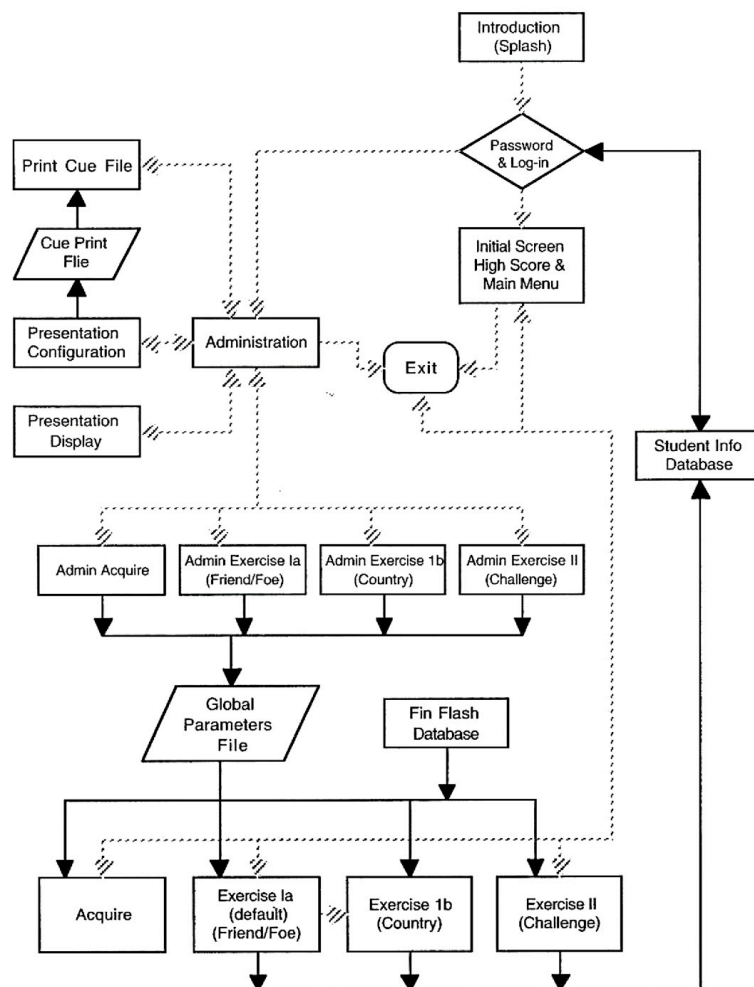

Figure 2.18. Program instructional flow from Twitchell.

Note. From *A rapid prototyping model for the design and development of instructional systems in practice: a case study* by D. Twitchell, 2001, Unpublished Dissertation, Utah State University, Logan UT.

Because these diagrams can be seen only in their complete, finished state, their evolution through the design process can only be guessed at (though item *i* makes it clear that screen shots that preceded it are slightly more primitive). It is natural to assume that

May (2006) observed that one of the aspects of this project was that a common design language was formed over time among the participants. It is evident in his report is that this language included a shared meaning of the design drawings drawn on the white board as well as the verbal exchanges. There are unique symbols and arrangements in the white board drawings that were apparently meaningful and recognizable to participants during the study, but which require some effort for an outsider to understand. In addition, the design (and the drawings) matured over time. Ideas that were vague early on, were changed and elaborated, demonstrating that the design progressed through stages to become clearer, both on the whiteboard and in participant's minds.

One of the most relevant observations May (2006) made was regarding *waves of design* predicted by Gibbon's Model-centered Instructional design theory. Gibbons—as a participant in the study—paraphrased Simon, “we represent and re-represent the problem until the solution appears.” May quotes Michael Schrage (1999) saying, “The point is that the prototype doesn't represent the product of a methodical development path; instead, it emerges from interactions around iterations of the prototype” and May observes “those interactions around iterations took the form of waves” (p. 128). Inside these large waves were smaller cycles where clarity and common vision were gained by discussion and negotiation. These waves and cycles are indicative of the method of solving ill-defined problems noted in the general literature review. They are also examples of the design cycling seen in Goldschmidt's (1991) dialectic of sketching. All of these processes going on simultaneously are centered on the drawings.

May's study was unique among the case studies that I encountered in the depth to which he analyzed the design process. Parallels between the general field of design and ID became clear in May because of his careful and thorough reconstruction of events and words. May's study is a wonderful window on the ID process in general and model-centered instructional design in detail.

To summarize, only two of the case studies reviewed gave insight in the role of design drawing in ID. The fact that I found so few speaks to the point that design drawing is not commonly discussed in ID at it is in the general design literature.

Results from ID research literature with design drawing as a topic. My search uncovered three important sources of research on the topic of design drawing in ID. They are an article by Figl and Derntl (2006), a dissertation by Botturi (2003), and the research of Paquette, et al. (Paquette, 1996; Paquette, Aubin, & Crevier, 1994; Paquette, Léonard, Lundgren-Cayrol, Mihaila, & Gareau, 2006). These three sources are reviewed below. They are part of an increased interest in Visual ID Languages (VIDLs) (Boot, 2005; Schatz, 2003; Seo & Gibbons, 2003; Waters & Gibbons, 2004).

One example of this increased interest is the report of Figl and Derntl (2006), comparing the value of three VIDLs for the design of blended learning courses. What all these VIDLs have in common is their connection to the concept of learning objects and the SCORM (Sharable Courseware Object Reference Model) standard. The three VIDLs compared are E²ML (Educational Environment Modeling Language), PCeL (Person-Centered eLearning), and EduWeaver.

E²ML, a VIDL by Botturi (2003) is a semi-formal modeling notation for creating and documenting instructional designs. It is derived from Unified Modeling Language (UML) used in object-oriented computer programming, substituting learning objects for computer-code objects. PCeL is founded on the person-centered philosophy of Carl Rogers (1983) but related to Alexander's (1979) concept of architectural pattern languages. PCeL includes a library of instructional patterns, modeled in UML activity diagrams, which serve as templates for the creation of instructional instantiations. *EduWeaver* is a Web-based courseware design tool that uses a modeling framework for grouping and sequencing learning objects into cohesive lessons, modules, and courses into its own visual format.

Of these three, Botturi's E²ML can notate the widest variety of instructional constructs. Botturi (2003) describes the intent of E²ML as a kind of blueprint for instructional designs, allowing all stakeholders in an instructional design effort the ability to agree on details of design. His goals for E²ML are to provide a notation system that will visually support design and development, document a design, and support evaluation.

One of the principal strengths of E²ML, like its predecessor UML, is the many varied types of diagrams that can be used for various purposes. This flexibility comes from adapting a majority of UML's views to instructional design purposes. Botturi proposes several types of ID diagrams, shown in this list of diagrams below:

1. Goal Definitions
 - a. Goal statement
 - b. Goal mapping
2. Action Diagrams
3. Resource Lists
 - a. Role and actor list
 - b. Location list

- c. Tool list
 - 4. Overview Diagrams
 - a. Course breakdown statement
 - b. Dependencies diagram
 - c. Activity flow
- (Botturi, 2003, p. 82)

Figures 2.20, 2.21 and 2.22 are examples of a few of these types of diagrams. Figure 2.20 is an example of a goal map (item 1b on Botturi's list, above), showing dependencies among instructional goals. The symbols on the diagram labeled "G1," "G2," etc., represent different goals, Figure 2.21 is an example of an action or activity diagram (item 2 from Botturi's list). Note the goals which this instructional action are supposed to address listed along the right side. Figure 2.22 is an activity flow diagram (item 4c on the list above), "A1," "A2," etc., are the identifiers for specific activities and the diagram shows their order of occurrence. All of the various types of representation in E²ML are related to design, and fall under type 1.

While E²ML's many types of diagrams give it broad coverage, nearly every diagram can be related to Gibbons' strategy layer in one way or another. However, most diagrams also contain elements for multiple layers and integrate those layers together. For example, the Goal Mapping diagram (item 1b from Botturi's list of diagrams above; see Figure 2.20 for an example) as well as his Dependencies diagram (item 4b from Botturi's list) address Gibbons' content layer as well as the strategy layer. E²ML's Action diagrams (item 2 from Botturi's list; see Figure 2.21 for an example), sophisticated tables of information, document some aspects of Gibbons' control layer, as does the Activity Flow diagram (item 4c from Botturi's

list; Figure 2.22 is an example). Despite the preponderance of connections to the strategy layer, many of these diagrams integrate support for other layers as well.

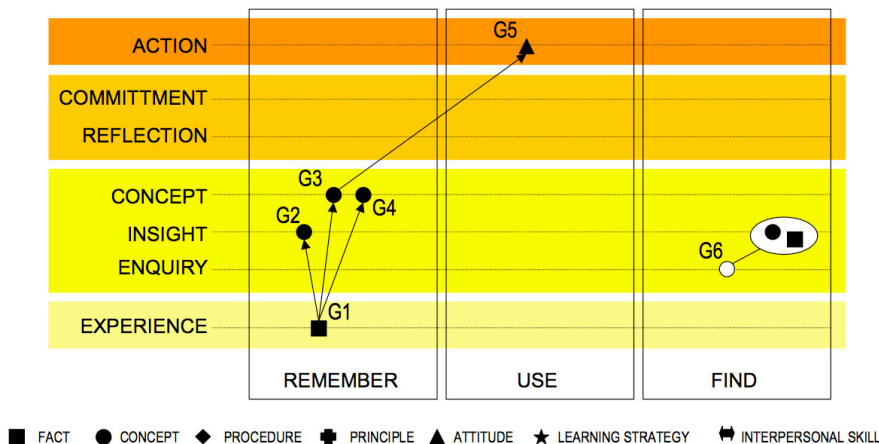

Figure 2.20. An example of an E²ML goal mapping diagram showing dependencies.

Note. From *E²ML: Educational Environment Modeling Language* (p. 94) by L. Botturi, 2003, Unpublished Dissertation, Switzerland, Lugano.

Botturi's goal for E²ML is that it serve as a means for detailing instructional designs with a high level of specificity like the finished blueprints in architecture, or the detailed orthographic projection drawings in engineering. E²ML is being used to provide unified curricula among schools in Switzerland with different languages and cultures. Its high level of specificity allows it to do this. E²ML portrays the final, detailed outcome of design thinking, not the process by which it occurred, much like the design document examples found in Twitchell's (2001) case study discussed above. Because of this, the process by which these diagrams were formed is for the most part not visible, nor does Botturi give us many details of how he arrived at the final diagrams. For most of the diagrams, we can only extrapolate how this approach might be used in the cycles of design and through stages of design drawings discussed earlier. On the other hand, E²ML diagrams provide a level of detail that supports collaboration (design drawing as a catalyst for social agreement) as well as

detailing, documenting, and communicating a fully developed instructional design (as a language of design).

Website analysis		WA
Students (all, assigned groups), Tutor		LEARNING
Master the W2000 hypertext design model	Increased mastery in W2000; critical analysis of a Web site (distinguish good design from errors)	G3
Browsing the Web; Using MS PowerPoint + MS Word	-	G4
The Web site to be analyzed	Analysis report (10 pages max., diagrams in PowerPoint)	G5
(Group) Visit the assigned Website, reconstruct its content and navigational structure. Represent it with W2000. According with the Web site requirements, identify design inconsistencies and potential usability problems. Write a report according to the guidelines (Tutor – available in defined timespans during the week) provide support and guidance at intermediate states of the analysis. DURATION: 8 hours in the 4 th course week		G6
[anywhere] PC129		
W2000 specification, course syllabus		

Figure 2.21. An E²ML action diagram.

Note. From *E²ML: Educational Environment Modeling Language* (p. 98) by L. Botturi, 2003, Unpublished Dissertation, Switzerland, Lugano.

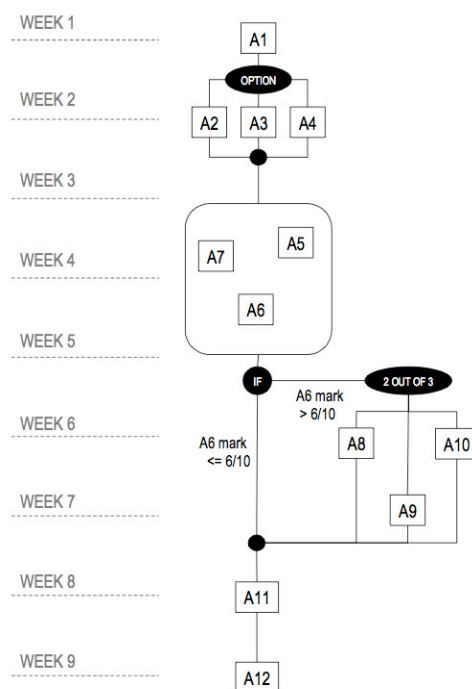

Figure 2.22. An example of an E²ML activity flow diagram.

Note. From *E²ML: Educational Environment Modeling Language* (p. 103) by L. Botturi, 2003, Unpublished Dissertation, Switzerland, Lugano.

Paquette (1996) created a graphic notation system, with supporting software, called *MOT* (an acronym for the French term *Modélisation d'Objets Typés*). *MOT* includes symbols (See Figure 2.23) for abstract knowledge classes (concepts, procedures, and principles), as well corresponding individual facts (examples, traces, and statements). Similarly, lines (arrows) connecting the symbols also come in a number of types. *MOT*'s abstract knowledge classes correspond to object-oriented programming classes and individual facts correspond to the instantiations of the classes.

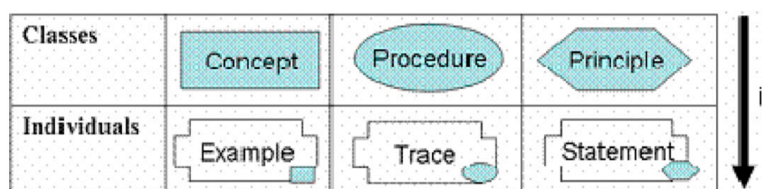

Figure 2.23. The integrated vocabulary of the *MOT* representation.

Note. From "Learning Design based on Graphical Knowledge-Modelling," by G. Paquette, M. Léonard, K. Lundgren-Cayrol, S. Mihaila, & D. Gareau, 2006, *Educational Technology & Society*, 9(1), 97-112.

Because *MOT* can be used for both abstract classes as well as specific instantiations, it is able to describe both models (types 4 or 5) and instances of instruction (type 1). Figure 2.24 shows an example of a generic cognitive skill model ("Simulate a process") on the left, and an activity structure based on this general skill ("Choose a multimedia production process") on the right. Figure 2.24 does not show a third level of specificity with specific instantiations of the classes in the general skill diagram, using the second set of symbols. The level of specificity it adds to the common hierarchical flowcharts of skills analyses, such as those found in Dick and Carey (1990), and in Gagné, Briggs, & Wager (1992) make it a good augmentation to these diagrams of content layer material.

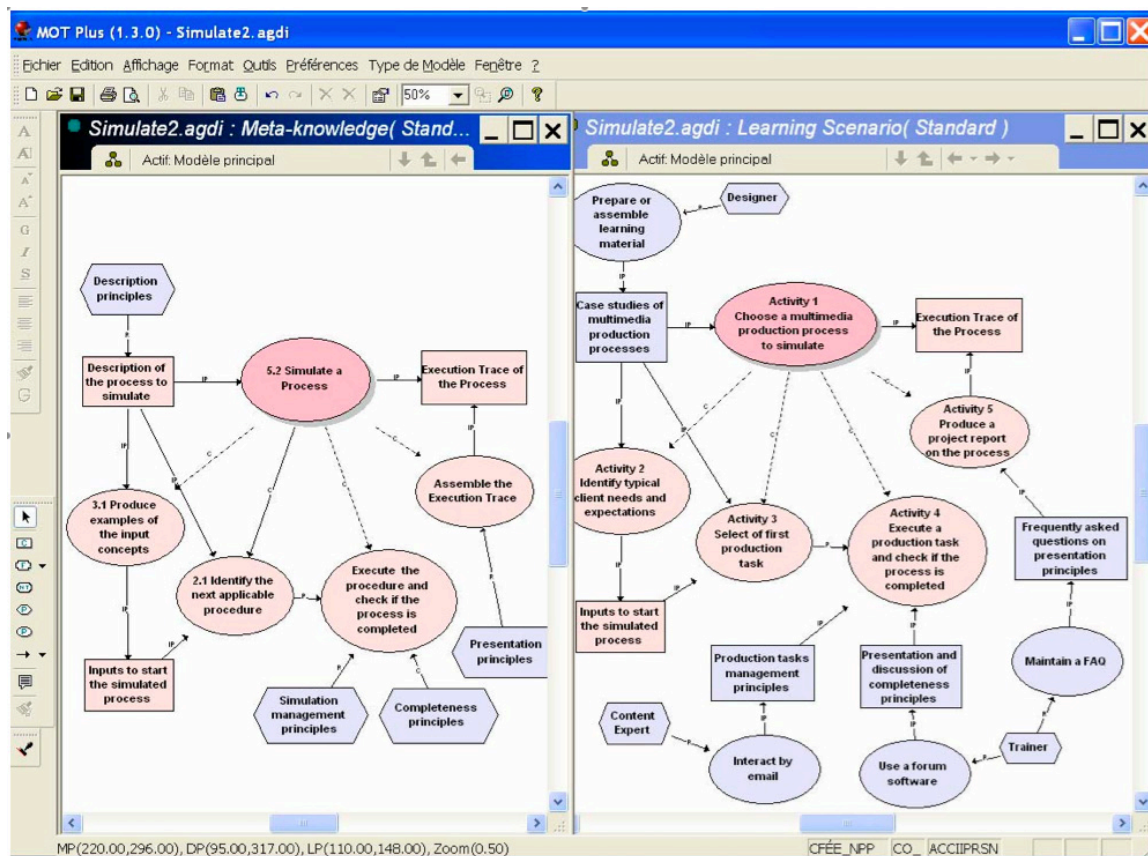

Figure 2.24. A MOT diagram showing both a meta-knowledge representation and a learning scenario.

Note. From “Learning Design based on Graphical Knowledge-Modelling,” by G. Paquette, M. Léonard, K. Lundgren-Cayrol, S. Mihaila, & D. Gareau, 2006, *Educational Technology & Society*, 9(1), 97-112.

Examples of MOT from Paquette’s writing most often document Gibbons’ content layer (for example, knowledge analyses), and strategy layer (for example, instructional activities). With MOT’s primitives, this notation system can be applied to virtually any general notation task that uses containers and arrows, such as Laseau’s (1986) bubble diagrams and networks. Because of its basic structure, MOT might be used to illustrate other layers of design if those layers can be illustrated abstractly.

MOT’s basic approach also makes it flexible enough to serve the various stages of design. As noted, Paquette (1996) and his colleagues have created software for creating MOT diagrams, but virtually any diagramming software that allows custom symbols (such as

Visio or *Omnigraffle*) would be capable of implementing MOT. In addition, MOT's symbol set and concept are simple enough that they could be the basis of hand-drawn design drawings.

Summary of Design Drawing in ID

In this section, I have looked for design drawing in the literature of ID from two perspectives. The first perspective was to look for specific examples of design drawings. Examples of design drawings were found, but were rare, and tended to document only two of Gibbons' seven layers: content and strategy. The second perspective was to look at the same literature for discussion of how drawing is used in ID. The few studies found were about proposed notation systems rather than studies of the advantages or effects of design drawing in practice.

Chapter Summary

This literature review of design drawing was really two literature reviews. The first was taken from the literature of design studies, a field of study that investigates design as the intersection of practices of several design fields like architecture, engineering, and industrial design. The second review examined the literature of ID. My purpose was to compare the understanding and level of interest in design drawing between instructional design, and other fields of design. I found that the field of design studies abounds in research on design drawing; ID does not.

The general design studies literature has both theoretical and empirical studies on the subject of design drawing. In this literature, design drawing is considered an important, even vital part of design thinking. It is thought of as a design language, which comes in a variety

of distinguishable forms, and accompanies and contributes to the design process as it progresses through various stages of development. Studies in this literature show how the intentional ambiguity of design drawing provides space to the designer for creativity and innovation, invoking a kind of dialogue between the designer and the design, which is deemed essential to the design process. Design drawing is viewed as a focal point for the sociality of design, and is the catalyst for design negotiations and agreement among people.

By contrast, the literature of ID has nothing like this level of consideration for design drawing. Instead, the few available articles in the literature of ID touching on design drawing are about proposed notation systems. Evidence of design drawing in the practice of ID as seen in the literature finds that, when it does appear, it is most often concentrated in two aspects of ID identified with Gibbons' content and strategy layers.

To say that there were no examples of design drawing in ID would be hyperbole. However, considering how little was found and how narrowly focused it was, it prompts the question, "What might ID be missing by its lack of attention to this language, so valued in other fields of design?" About design drawing as a language of design, Lockard (1977) observes that a lack of fluency results in the graphic equivalent of "curious speech stoppages, and deadly dull sentence structures" (p. 111). McKim's (1980) observation, mentioned earlier, that designers with versatility and skill in graphic languages have an advantage, may apply to instructional designers as well. They will, I suspect, "not only...find more complete expression for their thinking but also [they will be able to] re-center their thinking by moving from one graphic language to another." For its possible benefits to the processes of ID, design drawing deserves a thorough examination.

CHAPTER 3—METHODOLOGY

To explore the use of design drawing in ID, this case study began with a double literature review (found in Chapter 2). A case was selected and group and personal observations took place. Audio recordings, photographs, and field notes were kept for later analysis. Analyses of these artifacts were then used to understand the roles, purposes, values, and meanings the observed design drawings have to instructional designers and to the design process. This is a naturalistic study informed by Eisner's (1998) *connoisseurship*, and Dervin's (Dervin, Foreman-Wernet, & Lauterbach, 2003) *Sense-Making* methodology as well as Moustakas' (1990) *heuristic inquiry*.

In this section, we shall first examine some of the philosophical underpinnings of the method selected. Then the procedures of the data collection will be examined along with the types of evidence collected. Following that, the way the analysis was conducted, and the study's research standards will be discussed.

Philosophical Underpinnings

Exploration-type of Research—Gibbons & Bunderson

Gibbons and Bunderson (2004) describe three ways to produce knowledge: explore, explain, and design. Each of these three answer different questions, roughly, "What is out there?" (explore); "Why or how does it work?" (explain); and, "Can we make it better?" (design). What is generally referred to as "science" focuses on the second of these, explaining, while their paper focuses on the other two, exploring and designing research, "...to correct what can be viewed as a current under-emphasis in those areas caused by living in the

shadow of science” (p. 937). This idea echoes Rowland’s observation cited in Chapter 1, that the study of ID is tilted toward the “rational.”

Because it has not been adequately studied before, this study seeks to explore the phenomenon of design drawing in ID. Actual occurrences of design drawing were observed in an ID setting to explore their usage (rather than explain how or why they work or to design a better way to use them—though these are natural follow-up examinations to this study). A naturalistic case-study approach was selected to provide a realistic baseline of actual practice, which is needed before recommendations for changes can be meaningful.

Methods Used in General Design Studies—Craig, Cross, & Others

In the general field of design studies, Craig (2001) has identified four distinct strategies for studying design behavior. They are *think-aloud protocols*, *content analysis*, *process isolation*, and *situated studies*.

Think-aloud protocols, where the subjects describe their thinking processes as they design, work reasonably well with well-defined problems, but less well with ill-defined problems (such as design is thought to be) because the research must infer both the problem-space and the state of the subject from the subject’s interpretation of their underlying mental processes. Think-aloud protocols are very similar to ID’s content analysis, but content analysis shifts the focus of research from subjects’ individual experiences to the product produced.

Process isolation involves a controlled study of a design process, broken down with parts studied discretely. Breaking a design process down simplifies the creation and testing of hypotheses. The method requires well-defined dependent variables; unfortunately, the more

“real” design tasks become (e.g., the more ill-defined), the murkier dependant variables become, making the study more complicated and prone to error.

Situated studies focus on design behaviors in their social and cultural context, and in their material environment. Because of situated studies’ broad, often exploratory orientation, they provide a solid foundation on which to base more discrete forms of research like process isolation and think-aloud protocols. Situated studies typically focus on either the way meaning is produced, or the way social situation and material environment influence behavior. This method is valuable for qualitative studies, but difficult to use for controlled experimental environments.

Situated studies are a particularly powerful approach to the study of design because design is inherently situated; that is, design is best observed in situ, as it takes place. This overcomes the difficulty in uncovering meaning in analyzing protocols or content, as well as the artificiality of predetermined problems and situations found in process isolation. Situated study also lends itself to both the methods and the constraints of case study methodology. (Craig, 2001, p. 29 & 31). Situated studies are often presented as case studies.

According to Cross (2001) case studies, where actual events are observed, is one of the principal types of methodology used in the research in general studies of design. Yin (1994) compared five different methodological approaches to qualitative studies (experiment, survey, archival analysis, history, and case study) and proposed that the methodology be selected on the basis of the information being sought. If the research question is how or why, if control over behavior is not required, and if the focus is on contemporary events (as opposed to historical ones), case study is the preferred methodology.

In this study, how design drawing is used in real ID situations is being explored. Because we hope to see design drawing being used in a natural setting in ID, because experimental control over behavior is not desirable, and because the reality of events observed is important to understanding it in context, an exploratory, situated case study seems to be an appropriate methodology.

Guiding Principles—Stake, Eisner, & Dervin

Stake (2004) identified 10 “general orientations or styles or dispositions” of researchers that shape studies. These dispositions reveal the evaluator’s preferences for main questions as well as data-gathering methods. Notice that they do not necessarily determine the method, but may guide the method’s use. The ten dispositions are:

1. A accountability disposition, aiming at assuring program obligations are honored;
 2. A case study disposition, concentrating on a particular case and its complexity;
 3. A connoisseurship disposition, honoring scholarship and expert judgment;
 4. A democratic disposition, active in extending personal protection and choice;
 5. An ethnographic disposition, emphasizing cultural relationships and activity;
 6. An experimental disposition, valuing precise and objective knowledge;
 7. An illuminative disposition, providing what readers might see in themselves;
 8. A judicial disposition, emphasizing presentation of arguments for and against;
 9. A naturalistic disposition, valuing ordinary activities in their settings; and,
 10. A responsive disposition, fixing on issues and values held by stakeholders.
- (p. 30)

This study involves finding the value of an everyday experience—design drawing—in a natural setting (9, a naturalistic disposition). It also involves discovering what meaning and values the participants themselves attach to design drawings (10, a responsive disposition).

Finally, it examines the production of design drawings in the design process as observed by an expert or one familiar with the design process (3, a connoisseurship disposition). Stake (1995) would have identified this case study as instrumental (as opposed to intrinsic) because the case is instrumental to understanding something other than the case itself—in this instance, design drawing in instructional design.

Methods are considered naturalistic if the researcher does not attempt to manipulate the research setting. “The research setting is a naturally occurring event, program, community, relationship, or interaction that has no predetermined course established by and for the researcher. Rather, the point...is to understand naturally occurring phenomena in their naturally occurring stages” (Patton, 1990, p. 41). Guba (1978) defined “naturalistic inquiry” as a discovery-oriented method that involves minimal manipulation by the investigator and no prior constraints on the outcome. Patton (1990) further notes that naturalistic inquiry focuses on the actual operations and impacts of a process, program, or intervention over time. This accurately describes the conditions of the observations of made for this study, though not of the interviews. While at the beginning of each observed meeting, the purpose of my attendance was mentioned (as part of the requirements for IRB), my attendance was generally not disruptive to the flow of the meeting.

This study has also derived from a responsive disposition, to identify issues, values, and meaning held by stakeholders. The so-called *Sense-Making* method proposed by Dervin (Dervin, Foreman-Wernet, & Lauterbach, 2003) is used to help participants identify the meaning in their drawings and the processes that produced them. The Sense-Making method involves having participants report problems or gaps that needed resolution, then

identifying the bridges that helped them get across those gaps, or conversely, barriers that kept them from bridging the gaps. By conducting interviews in this *Time-line Interview* format, participants are able to reconstruct, step-by-step, how they made sense of a series of related events. This technique was used in interviews to help tease out what meaning participants assigned to the drawings they drew.

The connoisseurship perspective means that the researcher is not merely the human equivalent of an objective video camera recording events unemotionally and disinterestedly. On the contrary, my research and experience in this topic should serve to heighten my sensitivity to what is taking place. Schwandt (1998) described connoisseurship this way: “For the connoisseur, perceiving or experience is a kind of heightened awareness or educated perception...that comes from intimate familiarity with the phenomenon being examined” (p. 129). In this case, my informed observation of design drawing as it occurs is an advantage to the study (where my lack of objectivity might, in some research settings, be considered a disadvantage).

This case study is founded on principles of naturalistic inquiry, with some interviews using the Sense-Making methodology to understand the meaning participants give drawings, and informed by my prior study and experience.

Study Procedures

Selection of the Case

Stake (1995) points out, “Our time and access for fieldwork are almost always limited.” Therefore he suggests criteria for selecting cases use time and access as criteria: “If we can, we need to pick cases which are easy to get to and hospitable to our inquiry, perhaps

for which a prospective informant can be identified, and actors (the people studied) willing to comment on certain draft materials” (p. 4).

A number of entities in the local area qualify as “easy to get to,” who employ instructional designers—usually a good indicator for instructional design situations that might include design drawing. They fall into three categories: large corporations (which have internal and external training needs), small ID companies (whose products are instructionally designed), and divisions of local institutions of higher education (who do ID for their faculty). Stake notes,

It may be useful to try to select cases which are typical or representative of other cases, but a sample of one or a sample of just a few is unlikely to be a strong representation of others. Case study research is not sampling research. We do not study a case primarily to understand other cases. Our first obligation is to understand this one case...The first [selection] criterion should be to maximize what we can learn. (p. 4).

Given Stake’s maxim that cases should be selected on the basis of which provides the most learning, one local entity from the third category (a division of a local college or university) stands out as more likely to provide that: Brigham Young University’s (BYU) Center for Instructional Design (CID).

CID employs approximately 30 full-time instructional designers, artists, programmers, project managers, and support personnel, and has at times employed as many as 150 part-time student assistants. While all materials produced are for a higher education audience (one narrowing factor), they come from practically every subject area on campus. CID’s instructional products span all types of instruction from simple presentations to complex animated simulations to distance education courses. In contrast to commercial ID concerns, where products are likely to be built on pre-determined templates to support

volume production, CID's instructional designs are more likely to be "handcrafted," that is, to include basic and fundamental design efforts. This fact contributed to availability of design drawings for observation.

BYU's CID is a large employer of instructional designers; the instructional design work there occurs over a large variety of content areas and product types; design work tends to be more fundamental, permitting more opportunities to observe design drawing as it occurs; it has an organizational structure well suited for observation; and, it is easy to access and hospitable to inquiry. BYU's CID was the ideal subject for this study.

Because this study involves human subjects, approval from BYU's Institutional Review Board (IRB) was sought and received. This research protocol was classified as exempt, based on its minimal impact on subjects. Documentation for this permission is: BYU IRB# 05-0181, approved May 31, 2005. Pursuant to the specifications of that application, audio recordings are not generally available, and personal references (i.e., names) have been altered to make individuals anonymous.

Data Collection Process

Data collection consisted of three activities: a dual literature review drawn from literature outside as well as inside of ID, observation of instructional design meetings, and personal interviews. At observations, photographs of design drawings were taken, and audio recordings made. Field notes of several meetings and interviews were also taken.

Literature review. The literature review for this project should be considered part of the data collection because the nature of the study required a fundamental understanding of design drawing in fields outside of ID for comparison purposes. The literature review for this

study took place in two parts, one on the general literature of design studies, and a second literature review looking for evidence of design drawing in ID.

Because of the scarcity of literature on the subject of design drawing in ID, the first part of the literature review covered the subject of design drawing in the general field of design studies. This literature incorporates design fields identified by Cross, (2001) to include architecture, industrial design, mechanical engineering, and electronic engineering, among others.

Design drawing has been at the core of design thinking for so long (see Baynes, 1992; Cross, 2001) that the literature covering this subject is rich and deep. Much thought, discussion, opinion, and empirical study have created a mature literature on which to draw. This literature review provides an understanding of the roles and purposes design drawings play in the development of the design process, the value designers place on design drawing, and the various kinds of drawings that are done, outside of ID.

Because it is thought that instructional design should be considered a subset of the greater design world (Murphy, 1992; Rowland, 1993) this review of the general design studies literature helps create a basis for comparison with design drawing in ID.

The second literature review looked for evidence of design drawing in the practice of ID by examining a variety of ID sources, including textbooks, research journals, ID software and case studies. ID literature on the topic of design drawing was also surveyed. This second literature review identified the relative lack of research on the subject, and showed that what did exist belonged primarily to a narrow span of interest in ID.

Group observations. Once BYU was selected as the case, and permissions to make observations obtained, a strategy was formulated to schedule observations. Scheduling was set for approximately one month, roughly the month of June of 2005, to take advantage of a new round of projects just starting at CID, which would enable me to observe the early stages of several projects. Limiting observations to a one-month period was intended to constrain the scope of the study, and provide a snapshot view of design by observing several projects in various stages—especially early ones (as opposed a more longitudinal study of a single project or two throughout their lifespan).

During this observation period, most of the instructional design teams were observed in action. Attempts were made to observe all design teams; unfortunately, not all teams met for design meetings during the scheduled period. Where teams did not meet, I interviewed instructional designers and others about design drawing activities in ongoing projects instead, probing retroactively (see Personal & Follow-up Interviews, below). A total of eight design-meeting observations were made.

Teams were made up of an instructional designer, a content specialist, an artist, a programmer, a project manager, and others. Observations consisted mostly of attending design meetings and more-or-less silently watching the work of the design teams.

Most often, as these teams met, the whiteboard was used as a common drawing area, though personal notebooks were also used to make design drawings. Drawings on the white board or in personal notes were photographed for later analysis, paper field notes taken, and meetings were recorded with a digital audio recorder.

Questions to guide (silent) observations included, “What constitutes a design drawing? How will I know one if I see one?” “What is the ‘language’ of drawing used; that is, what are the primitives and grammar of the design drawing?” “What drawing techniques or approaches are applied?” “What types of drawings are being produced, and for what purposes?” “What elements of the instructional design are being represented in the drawing?” “What is the supporting narrative for each design drawing that supplies the meaning in context?” “What value is attached to these drawings?”

Personal & follow-up interviews. Originally, it was also my hope to silently observe “personal design” where a designer, artist, or programmer, sitting quietly in her or his office sketching out ideas. As it turned out, no personal design activities were observed. Though some of this activity occurred (as evidenced in later interviews) it was simply too difficult for interviewees to notify me when it was taking place, as it seems to have taken place impulsively, in odd moments when designers had time, and was never scheduled or planned in advance. A few follow up interviews, however, were conducted with some designers after design meetings to clarify and help understand what was taking place in the meetings.

As noted above, there were some design teams that were not meeting during the scheduled time period, who nonetheless had some design drawings to show. In these cases, I interviewed the instructional designer, and sometimes others as a substitute for group design meetings to identify some of the design drawing behaviors they may have noted. While not as valuable as direct observation, it did give interviewees the opportunity to interpret drawing behavior retrospectively.

A total of eight interviews took place. Three of those were follow up interviews after (multiple) design meetings; the rest were interviews in lieu of design meetings. The focus of all interviews was design drawings (as recorded or copied) executed in the performance of design work. In the case of follow up interviews, copies of design drawings, contextualized with information from my field notes was shared with interviewees to prompt recollection of values and uses of the drawings when they were created. Questions like the following were asked: “What problem/issue/need was this design drawing composed to alleviate?” “Did this drawing have the effect intended; that is, did it work?” “Why?” and “What happened next?” This line of questioning follows the Timeline Interview method outlined by Dervin. (Dervin, Foreman-Wernet, & Lauterbach, 2003).

Evidence collected. Three types of evidence were collected: 1) photographs of drawings and notes from the white board, notebooks, etc.; 2) paper field notes; and 3) audio recordings of meetings and interviews.

At all meetings and interviews, photographs were taken of design graphics on the whiteboard, and occasionally in the individual notes of participants. In addition, graphics referred to in interviews were also photographed, as were design graphics produced at other times for the project being discussed (such as storyboards and mock-ups produced by student artists under the direction of the senior art designer).

Careful field notes were taken at design meetings and interviews. Field notes are particularly helpful in showing the sequence of graphics on the whiteboard as design meetings progressed. Notes were coded to reflect what was being discussed or observed:

descriptive comments, content discussions, actions by participants (such as gestures), drawings, ID discussions, and ID process discussions.

All meetings and interviews to which I was a part were recorded with a digital audio recorder and files transferred to my computer for listening and analysis. There were meetings that had taken place before the study period started, and no audio recording of these was made, though sometimes pictures were provided (see above) and follow-up meetings and interviews recorded. During analysis, these audio recordings were correlated to field notes using time codes to simplify the connection between production of the design sketch and its context in the meeting. (As per requirements of the IRB, recordings are not generally available without special permission.)

Analysis Procedures

Classification of design drawings. Based on ideas from the literature review, drawings were analyzed and classified into three typologies for form, function, and stage in the process. The typology for form was modified from Laseau's chapters about abstract diagram forms bubble diagram, area diagram, matrix, and network, with representational added. A diagram usually takes on only one form, but occasionally it will have attributes of two forms. For example, a user-interface may use bubble-like containers to communicate navigation. In this instance, a diagram of the interface would include characteristics of both a bubble diagram and representative diagram (of the user interface).

Gibbons' layers of design were used to identify primary and secondary functions of each design graphic play in the design process. Gibbons' layers of instructional design include layers for content, strategy, control, message, representation, media-logic, and

management. It is common for a diagram to serve more than one function in design, but almost always, one function takes precedence, hence the identification of a primary and secondary function. These layers provide a convenient way to identify what aspect of design is being addressed by a diagram.

Finally, each graphic was categorized by which of five stages the drawing represented in a rough chronology of the design process, from beginning to end: ideation, negotiation, persuasion, crystallization, and communication. These stages were adapted from Lockard's (1977) recipients of design communication at for each phase. Lockard points out that a rigid movement from one to the next almost never takes place. Instead, drawings will often cover two or more congruent stages at the same time, picking up later ones, and abandoning earlier ones as the design progresses. This is reflected in the classification of design graphics for this study.

Context of design drawings correlated to field notes. Written field notes were correlated (by time code) to the audio recordings, and the construction of design graphics carefully recreated to identify structure of the graphics and their context to the design effort. Thus, not only were static images analyzed, but, their context (design dialogue during creation) and the manner of their creation (design graphics were often observed to be created dynamic interaction during the course of a design meeting) was observed.

Once the design drawings' context was reviewed, their classification by the three typologies above was reviewed for consistency. These were the source material used for the cases described in Chapter 4, results.

Assuring Trustworthiness, Research Standards

Williams (2002) in an expansion of Guba and Lincoln's (1989) criteria for assuring the trustworthiness of a naturalistic study offers several standards for naturalistic inquiry. They are credibility, transferability, dependability, and confirmability. Credibility is the standard on which the researcher can have the greatest impact.

Credibility. To support credibility, Guba and Lincoln (1989) suggest first two qualities a study should have: *prolonged engagement* and *persistent observation*. Roughly speaking, prolonged engagement represents a kind of breadth, and persistent observation, depth. Prolonged engagement usually occurs when the study's time-frame is long enough to build trust, both in the subjects of the study as well as in those reading it. While the actual time-length of this study was relatively short (roughly one month), my long-time personal connection with the subjects accomplished much of the same effect to enable me to see the range of things to be expected. For the same reason, because I am a known quantity, I felt there was little distortion due to my presence. Persistent observation requires that the phenomenon under consideration be studied in sufficient detail to discriminate between important and irrelevant details. The narrow focus of this study, combined with the thorough understanding provided by studying design drawing from other fields provided such a consideration of details called for by persistent observation.

It will be immediately noticed that my close affiliation with the subjects of this study are a potential source of subjectivity bias. However, considering the methodological bases of this study including Moustakas' heuristic inquiry (Moustakas, 1990; Patton, 1990) and

Eisner's connoisseurship (Eisner, 1998; Schwandt, 1998), it is hoped that my subjectivity in this study will be a benefit rather than a liability.

Guba and Lincoln (1989) also suggest methods to improve credibility: *member checking*, *peer debriefing*, *negative case analysis*, and *progressive subjectivity checks*. Member checking, in which results and analyses are shared with subjects for their additional feedback will be conducted after analysis for this purpose. Written descriptions were shared with participants to provide an opportunity for feedback and to determine whether they felt their perspectives had been adequately represented. Peer debriefing will be accomplished through the graduate committee of this study. Negative case analysis will be conducted as a matter of course during the analysis of this study as will progressive subjectivity checks.

Another method mentioned by Guba and Lincoln (1989) is *triangulation*. This study accomplished triangulation by means of multiple sources of information (including a number of participants as well as a thorough literature review) and multiple methods of data collection (including the literature review, multiple group observations and interviews). Neither multiple inquirers (I am the sole researcher) nor multiple venues (all subjects are employees of CID) are available as sources of triangulation.

Transferability, *dependability*, & *confirmability*. The three additional forms of trustworthiness mentioned by Guba and Lincoln (1989) and by Williams (2002) are *transferability*, *dependability*, and *confirmability*. While all three of these depend on others to accomplish, they can be facilitated by efforts of the researcher through thick description, which helps with transferability, care and consistency in the inquiry process which promotes

dependability, and an audit and audit trail to support confirmability. A thorough literature review also promotes dependability.

It is hoped that I have provided the kind of narrative suggested by Eisner's (1998) *educational criticism*, which I believe to be a good model of thick description to support transferability. Only time will tell if I have provided the requisite care and consistency in the inquiry process, but every attempt to do so will be pursued to shore up dependability of this study. Finally, though providing for an audit is beyond the scope of this effort, all field notes, copies of drawings, digital audio recordings, and analyses will be kept to provide an audit trail for subsequent research and to help with confirmability.

CHAPTER 4—RESULTS

The principal question this study seeks to answer is: “How is design drawing used in ID, and how does this compare with its use in other design fields?” In this chapter we will review three example cases which illustrate uses of design drawing in instructional design. As we look at them we will point out those places where they correspond with what would be expected in the general literature of design drawing found in the literature review, as well as any surprises we encountered. These observations of the usage of design drawing in ID, comparing them with other fields of design, will provide a baseline for further studies about this design language as it applies to ID. We will examine three particular cases of the use of design drawings: Steven & Tammy, Natalie & Kyle, and Nathan & Larry.*

Case One: Steven & Tammy

Steven has been an instructional designer with CID for over five years. He has been involved in some of the most interactive projects CID has produced, and is often the instructional designer of choice for simulations and scientific topics. Steven’s production team was selected as the designer for a course redesign of Biology 100. During the period of this study, two meetings were held to discuss Biology 100 development. Steven was interviewed for this study as a follow up to these meetings.

The first meeting was attended by Steven as the instructional designer; Tammy, the client and Subject Matter Expert (SME) for the project; Melissa, a project manager; an artist; and two multimedia programmers (one was just leaving CID, and the other was her newly hired replacement). This first meeting was called an “initial design meeting,” but Steven and

* All names used in Chapter four are pseudonyms, unless otherwise noted.

Tammy had previously met on the subject, and had already begun considering various approaches to the course redesign. Because of this, the purpose of this meeting was to introduce the rest of the team to the client, to the project, and to discuss logistics of future development. Strictly speaking, this was not a design meeting; it seemed to be to let the rest of the team in on what Steven and Tammy had been talking about. The meeting, started with a discussion between Steven and Melissa, the project manager, about what type of meeting this was to be—meaning, who should take charge, him or Melissa. With Melissa’s encouragement, Steven took charge of the meeting as leader-facilitator.

Steven introduced Tammy, the client/SME for the project, and asked her to explain why they were meeting with the team. Tammy explained, “The way the course [Biology 100] is structured now, it’s not really helping some students. It’s another hoop they have to jump through to graduate...[In our student surveys], we usually get blasted by them. They don’t like the course in general because they don’t find it useful. So, we’re looking at how we can revamp the whole course to make it useful, and then what kind of technology we can bring to the course to help us make it a little more intimate course, along with our goals of making it useful to the students.”

As Tammy talked, Steven wrote the name of the course, that it is a required course, and then, in outline form below that, he added, “– active” and “– relevant” as a summary of Tammy’s comments (see Figure 4.1). Because these two words are not precisely what she said, a discussion ensued about what they mean. Tammy argued, “I’m worried about how we can make it an ‘active’ course with [80 sections of about 25 students each, per semester]. Steven responded by teaching Tammy and others in the room what he meant by those

terms. After some discussion, Tammy conceded, and Steven left the writing on the board. The words on the white board were a focal point of the discussion, but were not changed because of it.

As Tammy continued her explanation, Steven drew a line and wrote under it “theme —> stewardship.” This was written starting from the left, like a new heading in an outline. Steven then prompted Tammy to provide the content items they had discussed earlier, as he wrote them in outline fashion under the previous writing. As she stated them, Steven left a blank space at the top of the list, then wrote, “Chemistry,” “Cell biology,” (then he indented and wrote the word, “Genetics,”) then (back to the left again), “Ecology.” (See Figure 4.1). The last term provided by Tammy was “Scientific method,” but, as she said it, Steven suggested it should be first because of its importance, and Tammy agreed. Steven wrote it in the blank space he had left earlier at the top of the list.

In response to a question from another member of the team about the meaning of “stewardship,” Tammy noted the ineffectiveness of traditional methods (such as memorization) and reinforced how stewardship will both connect with spiritual values and hopefully inspire teaching and learning methods that will make learning relevant. Steven added the words, “—> abilities to be good stewards” at the bottom of the list, at the same indentation as “Theme —> Stewardship” above, effectively framing the content list between them (See Figure 4.1). Steven then replaced the cap on the white board marker and sat down. It was approximately 11 minutes from the start of the meeting.

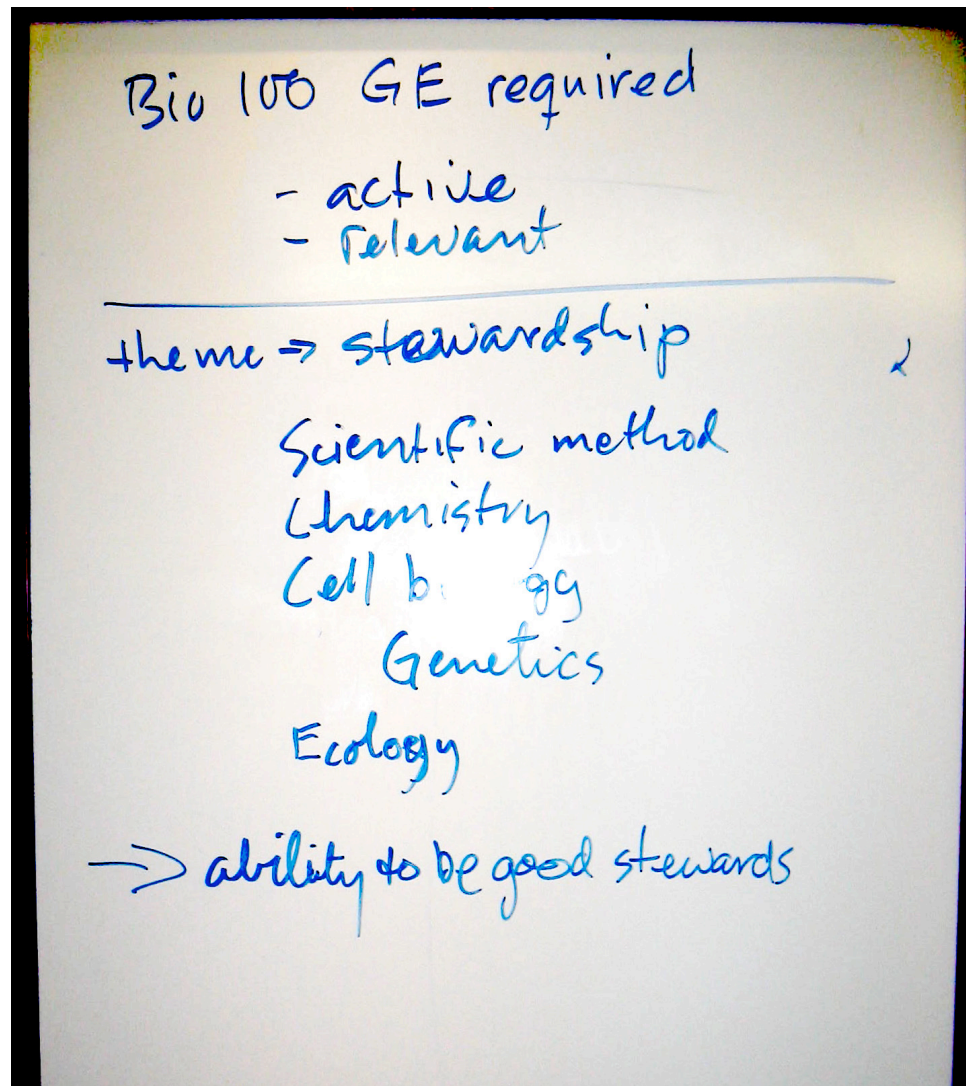

Figure 4.1. Photograph of the white board at the conclusion of the Biology 100 first design meeting. (Note: all photographs in Chapter 4 have been enhanced to increase legibility.)

At this point, the purpose of the meeting changed from overview to details as Steven presented his proposed solution. Neither Steven nor anyone else altered this outline and it was barely referred to again for the rest of the meeting.

In my follow up interview with Steven, I asked him why he used an outline instead of some other abstract form such as bubble diagrams. While I believe it had something to do with his skill with words, he explained that, “an outline is the easiest way to represent a series

of things and relationships between them. It's common, so it's familiar to people. Bubble diagrams get a little more difficult to interpret." When I asked what problem he was trying to solve with this outline in the Biology 100 project using Dervin's, (Dervin, Foreman-Wernet, & Lauterbach, 2003), Sense-Making interview technique, this exchange was the answer,

"This was the first meeting that everybody had a chance to see what the project was going to be. I wanted to give the over-arching theme and structure (to some degree), to communicate the goals and directions of the project."

"Did it work?" I asked.

"Pretty much," he responded, "...There [was] agreement on the overall direction, it's just that [Tammy is] unused to implementing instruction in this way."

"What do you mean?"

"You saw the [terms] in there, 'active and relevant.' She is unused to implementing a more active learning approach. So she keeps going back to a more traditional, more passive, spoon-feeding approach, and I have to keep reminding her." Steven said.

"So, you used the diagram to help convince her?"

"In some ways, I guess. Not so much convince. I would say she's convinced of the concept or idea or the approach, [but] she's not yet used to implementing it...Really, probably the thing was to get it [written] down. Once you get something down in writing, that kind of cements it. It is no longer just ideas floating in air, that you can massage any which way. Once you put something down in writing, you say, 'Here it is,' and everybody kind of agrees. You can now go back to it and say, 'Now remember, this is what we agreed to.'...[If] everybody agrees, then basically it's the ruling understanding, unless you renegotiate."

The purpose of the outline on the white board was more than informational;

Steven's later explanation describes the drawing as a level of commitment, precisely as would be predicted in the literature of design drawing. That this outline did not occur in

discussion, and occurred in the first few minutes of the meeting probably shows that it was composed earlier by Steven and Tammy. The present meeting was obviously to communicate the facts of that earlier agreement to co-professionals, as in Lockard's second stage of communication: (2) inter-professional communication. The presence of the client, and the fact that the other professionals in the room were the production team means that this outline also provided Lockard's stages three and four, (3) client communication and (4) builder communication, as well. In my adaptation of Lockard's stages, this communication had already moved beyond stages one and two, (1) ideation and (2) negotiation, and were on to stages three and four, (3) persuasion and (4) crystallization, and possibly even five, (5) dissemination. The discussion between Steven and Tammy about the words active and relevant threatened to return to negotiation, but a quick, on-the-spot exchange moved the conversation past that and on to the later stages.

One question that needs to be addressed is: Is an outline a design drawing? Typically, outline is a list of text, sometimes organized in a particular way to show hierarchy by indentation or numbering. However, definitions of the word outline could be used to describe design drawings as well (for example, "a draft of a diagram, plan, proposal, etc.; summarizing the main points." *Oxford American Dictionary*, 2005). Probably the best case of outlines as a kind of design drawing is their use in this context. At one point Steven leaves space at the top of a sub-listing in the outline to make room for an item which Tammy has unintentionally left out until last. When she finally mentions it (last), they agree to write it first in the listing, because they deem it the most important item. Clearly, the way Steven was using the outline, the vertical placement of items on the list has meaning (ordered by

importance). Because it is in outline form, indentation—horizontal placement—suggests another meaning: hierarchical relationship. The fact that both vertical and horizontal relationships have meaning puts this outline in the category of Laseau’s (1986) matrix form of design drawing. I believe it is safe to conclude that, at least the way Steven uses outlines, they are a form of design drawing. Outlines are a matrix in which horizontal and vertical placements of items have specific meaning.

A few days after the first meeting, Steven and Tammy met again to work on the detailed design of the Biology 100 project. Where white board drawings of the first day occurred in the first few minutes, in this meeting, the white board sketches were more part of the ongoing discussion between them.

This conversation began with the selection of a biology problem or issue to use as the basis of a learning activity. Steven proposed the issue of evolution versus natural selection and they both agreed it was sufficiently timely and controversial to make a perfect issue or problem for their learning activity. They then discussed ways of using this issue in a contrived situation for the presentation of arguments, to give students a sense of reality and motivation for their presentations. Steven proposed simulating a school board meeting, using other faculty and guests as the panel. He wrote “School Board” on the white board just to the right of the center of the board (see Figure 4.2) and proceeded to argue for it. In this activity, each side of the issue, the pros and the cons, were to be presented to the panel. As they discuss this activity, Steven repeatedly pointed to the words on the board. As Tammy added her ideas to how the activity would work, she also nodded toward the words “School Board.” Clearly, as excitement about the activity began to build, the words began to contain

more than their literal meaning, they came to imply the entire activity as described and defined by Steven and Tammy together. This reflects the creation of a new design language between them as proposed by Gibbons (2003) and observed by May (2006).

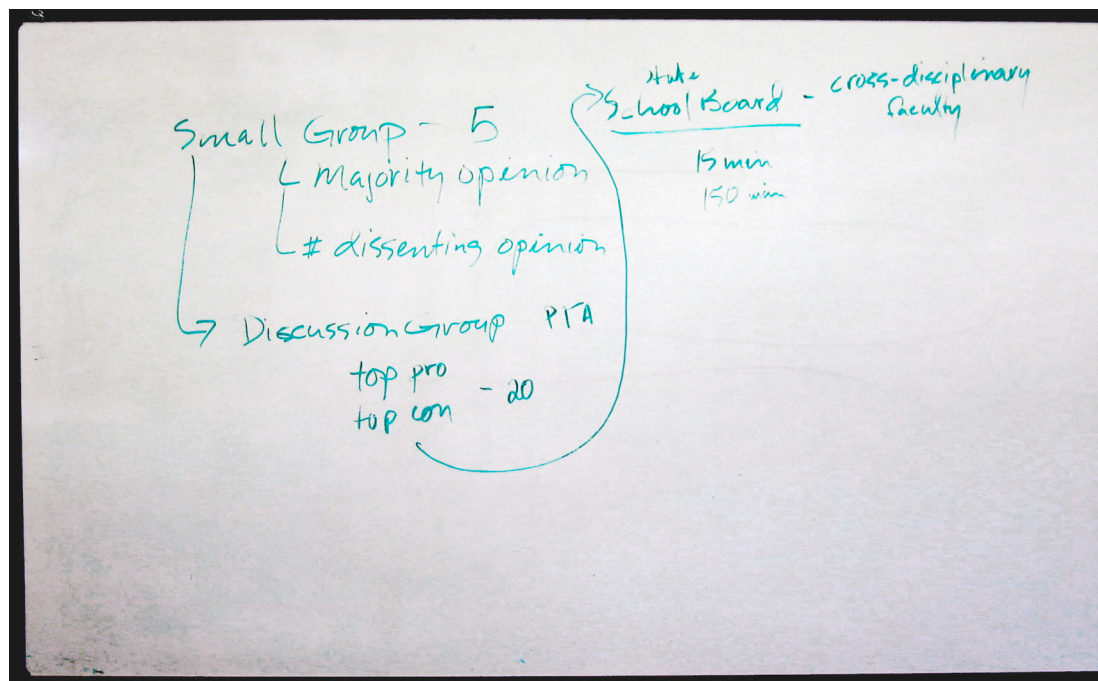

Figure 4.2. Board at the end of the second Biology 100 meeting

At this point, they began to clarify details about management of the activity writing on the board as they did so: the size of the group (“Small Group – 5”) and what will be included (“→ Majority opinion” and “→ # dissenting opinions”). It is decided that five groups in each section of 25 students will present, and the best of these (“top pro” and “top con”) will present at the final meeting of the whole class, for “20” minutes each (the presentation at the school board meeting is represented by the arrow from under there to the words “School Board”). The larger, final presentation will take place at the end of the semester and will be like presenting to a “state” school board, and Steven added the word

“State” above “School board.” In the smaller, sectional meetings, Steven and Tammy calculate the amount of time that the sections will need (“15 min” and “150 min”).

In addition to the white board, gestures were used for design communication very much like ephemeral graphic representations. At one point in the meeting, Steven was discussing three different options. He held out three fingers (pointed toward Tammy) and touched each finger as he described each option. The fingers were not merely counters; each finger came to represent a specific option. At one point in this exchange Steven said, “Now you can do it any one of these three ways; I’m not telling you which one you should do...” As he said this, he wagged his fingers back and forth indicating the tentativeness of the choices. The fingers represented a transitory design language vocabulary, much as the words “school board” represented a more permanent one. This use of gesture as a momentary drawing-like place-holder was unanticipated in the literature.

This entire meeting was much shorter than the previous meeting (about 35 minutes), and this time, the drawing is clearly integral to the entire meeting. The drawing helped focus the discussion.

The use of the white board during this meeting shows many characteristics of design drawing. There is evidence of movement through the early stages of design: (1) ideation, (2) negotiation, (3) persuasion, and the beginnings of (4) crystallization. When the discussion about the “school board” activity was introduced, the creativity and excitement indicated Goldschmidt’s *seeing as* thinking occurring. Later, as they discussed the operational details of the activity, the conversation shifted to Goldschmidt’s *seeing that*. This larger cycle was reflected in smaller cycles that took place during the conversation, that is, between leaps of

imagination (*seeing as*), and judgments about the newly proposed changes, bringing them “down to earth” (*seeing that*), all facilitated by the drawing on the white board. In addition, the drawing is quite difficult to interpret without the accompanying narrative; the narrative is essential in understanding it, though the general gist is available to the casual viewer, with some effort. Also, the drawing supported agreement and commitment to the ideas as they were discussed. Goldschmidt’s dialectic brought about the desired “shared vision” (Bucciarelli, 1994) the real design in this situation. The use of the fingers and other gestures as an extension to the design language, which was very graphic-like was not anticipated nor predicted in the literature.

There is some indication that the person at the white board at any given time, has control of the meeting, rather like the chair in parliamentary procedures. At the first meeting, when Steven was at the white board, he called on Tammy to explain to the group the previously discussed content, and wrote what she said. But he controlled the direction of the discussion, as evidenced by the brief controversy around the words “active” and “relevant,” and by his ordering of the words in the list (putting “scientific method” first in the list, though it was mentioned last). The power of the person drawing in a group context was not mentioned in the literature reviewed for this study.

A third meeting involving Steven on a different project (Biology 120) portrayed this aspect in even more dramatically. In that meeting, as in the first meeting, Steven stood at the board and wrote an outline based on what the client said he needed (see Figure 4.3). In this meeting, the client, Earl, was more vocal, and more in control of the discussion than in Biology 100, answering questions, explaining suggested solutions, and stating opinions. At

one point, he asked if he could write up the modules he has in mind. On another panel of the white board, he wrote up his own list (Figure 4.4). Steven's outline was based on objectives (Gibbon's strategy layer) with some content thrown in (see Figure 4.3); the client's list was pure content (Gibbon's content layer; see Figure 4.4). It seemed that the client felt the need to "take control" of the meeting to tell the story his way and used the list on the white board to facilitate that. While the list is of the content layer, his discussion about the list was almost entirely from the strategy layer (how his is not working and he needs help improving it).

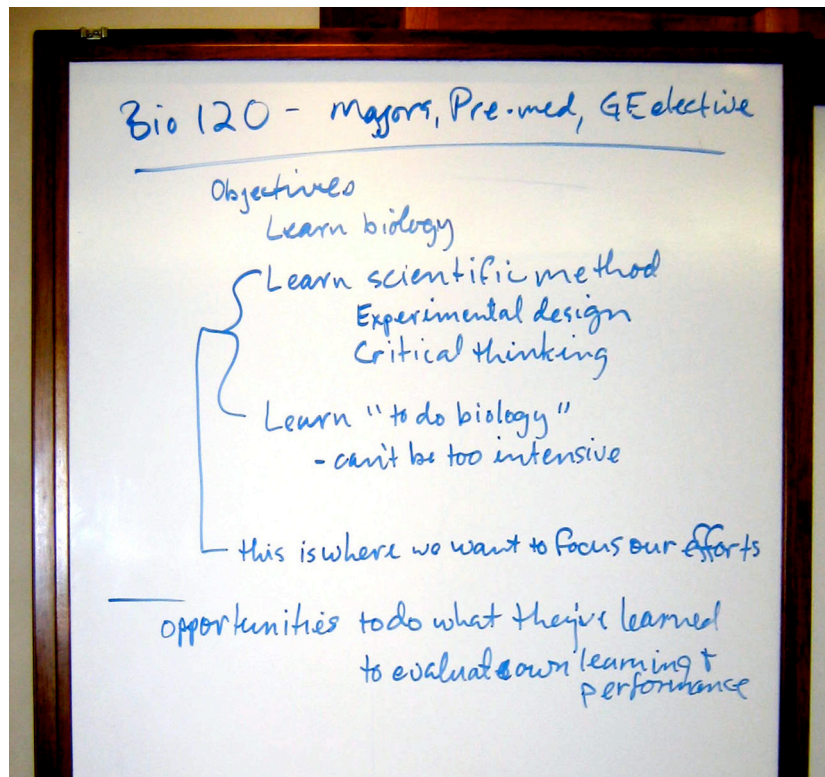

Figure 4.3. Steven's Outline for another project, Biology 120.

In this meeting, Steven's role was reduced somewhat from discussion leader to the true, virtually silent "chair" role, where he did not contribute as much. Most of the rest of

the meeting was listening to the client or asking him questions. The second list as a design drawing served to shift the locus of power from Steven to the client, Earl. The use of the common design drawing as a locus of power was not anticipated in the literature about design drawing. To his credit, Steven seemed fine with this secondary role; his focus seemed entirely on communicating clearly the intents of the project no matter who was doing the communicating. This was indicated by his asking clarification questions to which he may have already been privy to the answer, to prompt the client to inform the others in the room.

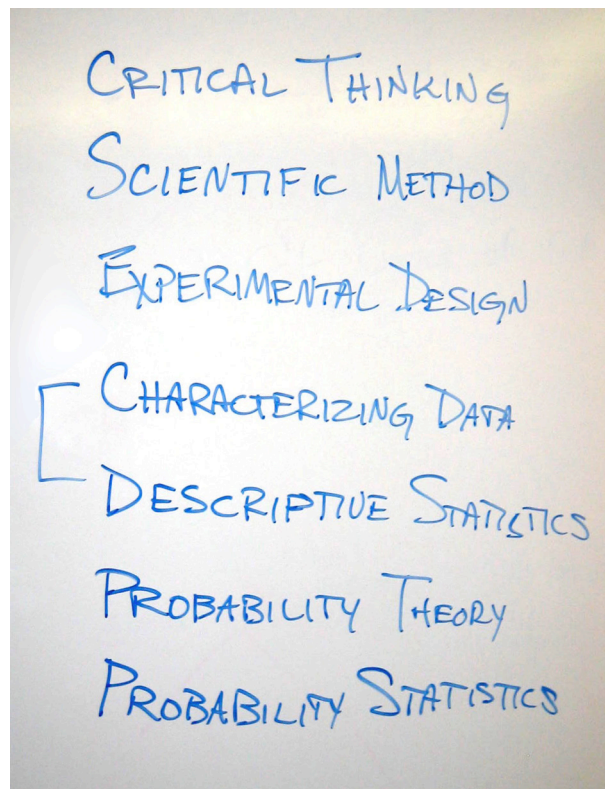

Figure 4.4. The list for Biology 120 written by the client, Earl.

Case Two: Natalie & Kyle

Natalie was a recent graduate of BYU's Instructional Psychology & Technology (IP&T) program with a master's degree. She had been involved in several of CID's outreach

programs, such as putting on workshops, seminars, and conferences for faculty. She had been at CID for approximately two years; initially as an intern, and for the last year as a full-time instructional designer.

At the time of this study, Kyle had been at CID for three years and had served in a number of roles. He was at this time the manager of a small team of students who made small, quickly-produced multimedia projects for faculty. His background was Web development: he had developed Web sites for a large corporate client. But, he also had a master's degree in instructional technology and was a doctoral student in BYU's IP&T department.

The internal project assigned to Natalie and Kyle was training for a piece of teaching and learning software to be available campus-wide. This product, Macromedia Breeze, allows faculty to add a video track to PowerPoint presentations and time the slides of the presentation to the video, among other things. It is used to make stand-alone tutorials and virtual lectures. Natalie was a member of this team because of her responsibility and experience with CID outreach. Besides being a skilled Web designer, Kyle had been involved in customer support of another software tool, and was aware of the ramifications that good training would have on support calls.

Two meetings were held, and in both cases, Kyle and Natalie were the sole participants. The purpose of the first meeting was to build the foundation of the assignment and begin design. During that meeting, both went away with the assignment to come up with storyboards for the next meeting. The second meeting was to refine, and if possible, integrate their different visions of the project into a cohesive product.

The first meeting started with an overview of the process Kyle had developed to support teaching and learning through the faculty lab which he managed. He had used a modified version of ADDIE (called DADDIE, with the addition of *Diagnosis* as the first step) and attempted to tie this training to the services provided at CID in general and the faculty lab in particular. This approach was in part to make it mesh with current practices at the faculty lab, and to provide a developmental framework.

Unlike other projects, this one seemed to have no pre-conceived form. This necessitated the design effort starting from scratch. When asked about this in a later meeting, Kyle said,

“Natalie and I had been talking for about a half hour; this was supposedly our kickoff meeting and it really felt like we weren’t making any progress. That’s why we [went to the white board] and began sketching out what we had. Even just sketching out the outline of what we had immediately helped me feel like we were moving just a little bit.”

I asked, “Was it just the feeling, or was it that you were moving forward?”

“It was both! It’s a ‘chicken and egg’ thing probably. Did we move forward because it started to feel like it? Probably, but also when we had something tangible, we had something we had accomplished, too.”

(See Figure 4.5. The list on the left hand side is DADDIE, the second column, with arrows is their connection with the Breeze training.)

With the first hurdle of “accomplishing something” past, Kyle and Natalie sketched out a rough linear flow diagram (the right-hand side of Figure 4.5) with boxes representing parts of the sequence (really, Web pages) of the training. Finally, near the end of the discussion, all this coalesced into a metaphor that brought life to the discussion. One of the issues that they found in conflict was the difference between providing an open- access

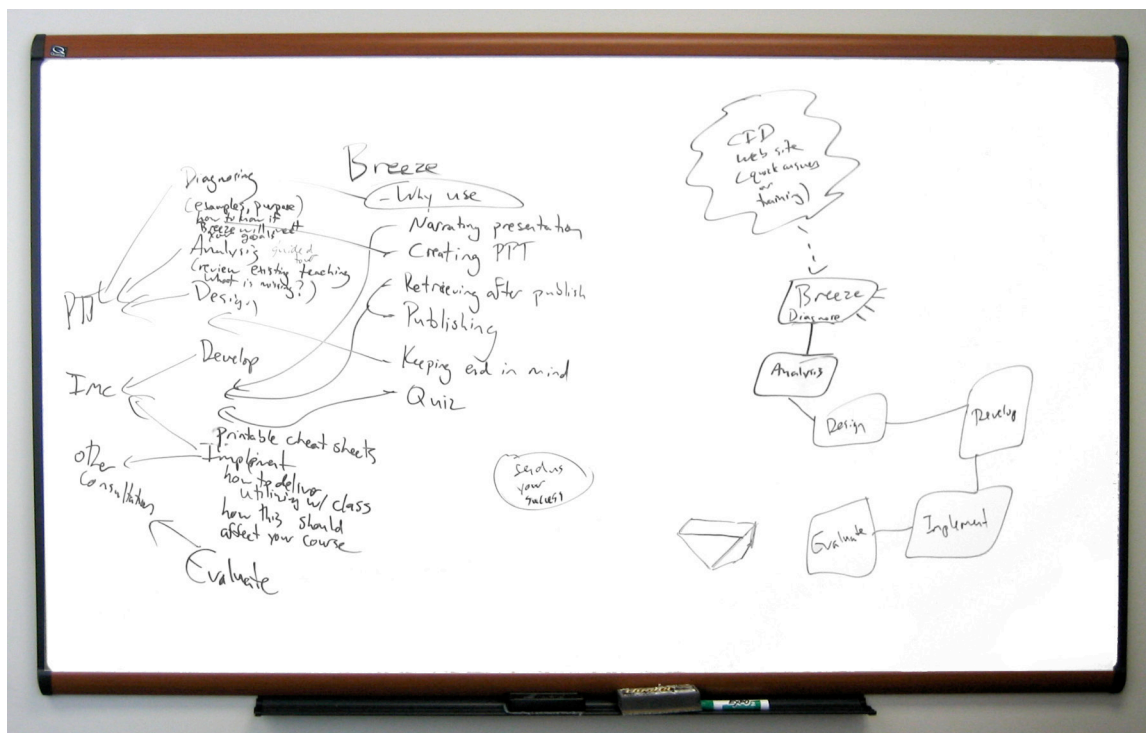

Figure 4.5. White board after Kyle and Natalie's initial Breeze tutorial meeting. Note the "diamond" (triangle) in the lower right.

instructional training product where participants could enter at the point of need, and one that assumed linear presentation. The triangular symbol at the bottom center of Figure 4.5 represents a diamond. According to Kyle, the diamond's facets may be viewed in any order, or one may be led to view the facets in a particular sequence. In a later interview, Kyle, pointing at the triangular shape, said,

This is my poor attempt at drawing a diamond. This is our metaphor for the site. This is what I was trying to communicate: it is linear—but not. We want people to think about this whole process as a beautiful diamond. That they may be looking at it here, then they turn in and they're looking at it here, but the whole time they're looking at the whole diamond. So, even though we're doing one thing at a time, we want to communicate that it is part of the whole. We're artificially narrowing it for now to focus on this one part, but don't forget the other parts.

We don't necessarily want to force people through a linear path, but we also kind of do....[There will be a menu of some kind that will allow them to jump around, but] somewhere prominently on the page will be a "Next, Go here" to direct them to the next thing [in the linear sequence].

For the follow up meeting, Kyle explained, "We want to each do our own set of thumbnails and then next week we're going to get together again and marry our thumbnails together." Natalie and Kyle each came prepared with their own thumbnail sketches of what the proposed Web-training should "look like" (whether literally or conceptually was not determined, and that has a bearing on the outcome). Figures 4.6 and 4.7 are these storyboards from Kyle and Natalie. What they were not prepared for was that their story-

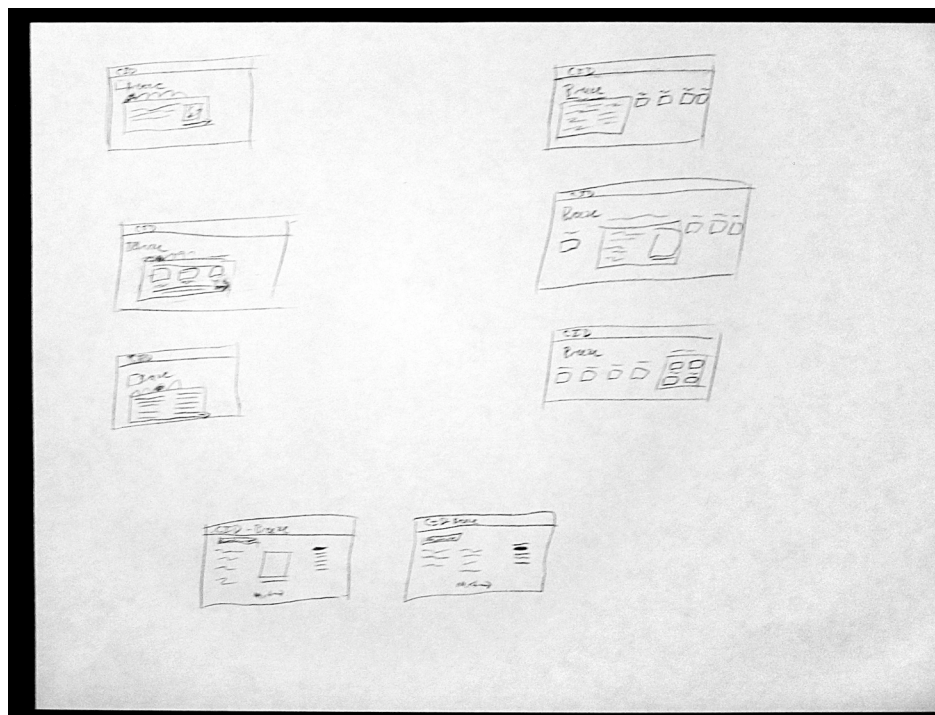

Figure 4.6. Kyle's storyboards. Kyle presents three options with two or three screen representations for each one. The tabbed style on the left was selected.

boards (or wireframes) described different aspects of the project in such a way that "marrying them" was quite easy. Kyle's drawings (Figure 4.6) were options for the user interface design.

As such, they were focused on Gibbons' layers for control, message, and, especially, representation. Natalie's drawings (Figure 4.7), on the other hand, were focused on the

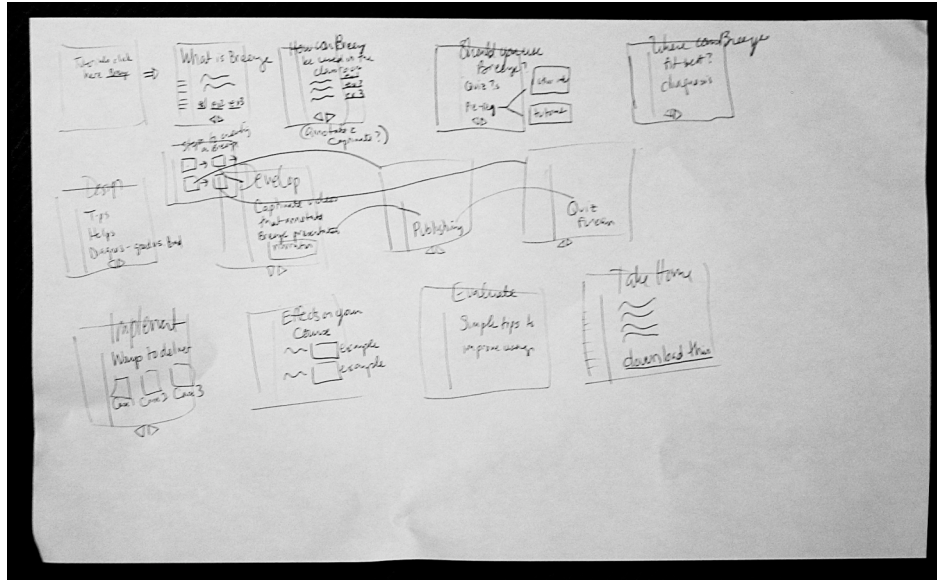

Figure 4.7. Natalie's storyboard shows some concern with screen layout, but is more concerned with content and flow.

content and instructional flow (Gibbons' content and probably strategy layers.) Her understanding of the diamond metaphor, meant offering multiple choices of examples and “case studies.” Kyle's drawings were options for screen designs, not flow, so it was fairly simple for the two of them to select one of Kyle's screen representations (they chose the tabbed screen metaphor), then apply it to the content flow Natalie had produced. The main thrust of the meeting was to do that work on the board together. By putting this merger on the white board and discussing it, issues that might have otherwise been hidden were teased out. In addition, unexpected connections between parts of the design were also made.

The result of this integration is found in the picture of the white board made at the end of this second meeting, Figure 4.8. At the beginning of the meeting, Kyle presented his

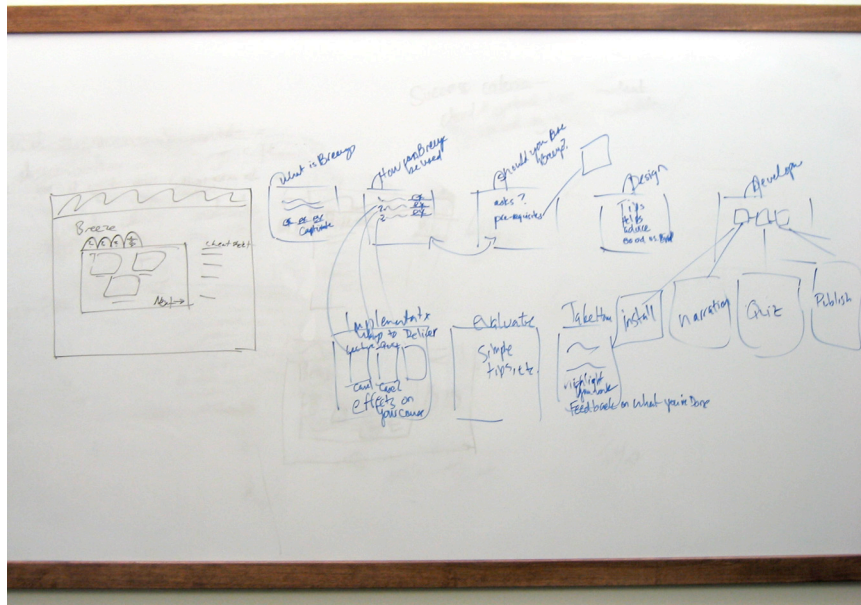

Figure 4.8. The white board at the conclusion of the second meeting with Natalie and Kyle. Kyle's proposed screen layout/metaphor is in black on the left. The remainder, in blue ink, is the integration of that user interface with Natalie's flow diagram. (Smudges in the original.)

three options (these include the image drawn in black on the left in Figure 4.8; what is left of the others are the smudges visible in the figure). Each was discussed briefly, and the tabbed interface was selected. All the others were erased, and then they proceeded to apply the tabbed interface to Natalie's flow version of storyboards. It fit neatly into the interface, and the drawings allowed Natalie and Kyle to discuss them one at a time as they were drawn. As mentioned, Natalie was trying to introduce multiple access points through the examples (options 1, 2, and 3 in the third box from the left). Later in the discussion, she proposed implementation cases. Correlating the two made sense, but would not have been visible without drawing the sketches on the board and discussing them.

At the conclusion of this meeting, both Natalie and Kyle expressed satisfaction in the design produced. It was carefully copied onto paper for future reference, see Figure 4.9.

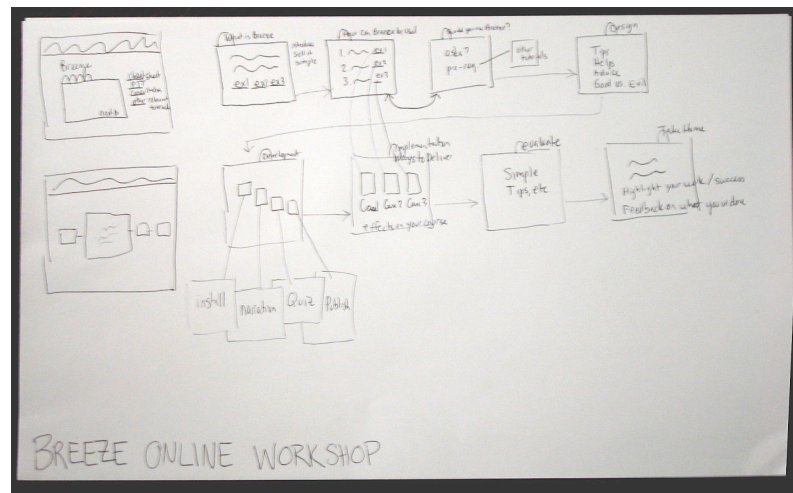

Figure 4.9. The paper copy of the white board diagram after Natalie and Kyle's second meeting.

In the first meeting, the effort that Kyle described as a way to get things moving was almost certainly ideation of the exploratory kind. The ideas were vague and free-ranging. However, the added use of drawing as an “icebreaker” was not mentioned in the literature. Working on the mutually agreed upon assignment to come up with thumbnails constituted the first of Lockard’s stages, (1) self-communication, and the second meeting is a clear example of (2) inter-professional communication. These are paralleled in my adaptation of Lockard’s stages, where (1) ideation and (2) negotiation are demonstrated. Because of the cooperative feeling between Kyle and Natalie, I did not sense much of the third stage: (3) persuasion in that meeting, though there was certainly some (4) crystallization taking place. The nature of the drawings was almost completely representational on Kyle’s part (screen renderings, Figure 4.6) but Natalie’s thumbnails (Figure 4.7), though they look very similar to Kyle’s, are a type of bubble diagram with some representational aspects. Examples of Goldsmidt’s dialectic of sketching was also evident in the back-and-forth in the conversation between Natalie and Kyle as they merged them. As they drew each new tab on the screen,

the ideas came easily to supplement the concept as it was merged (Goldschmidt's *seeing as*); then once on the board, the discussion would turn to judgments about what would work best for the training (Goldschmidt's *seeing that*).

The finished, merged drawing shows concern for Gibbons' layers content, strategy, control, as well as some aspects of message, and representation; in addition, media-logic and data management layers were discussed verbally during the production of this drawing. In all, this is a very complete example of design drawing as a catalyst for shared vision, it having generated discussion for all necessary parts of the product. To complete this design, there will need to be detailed plans of each of those layers created; but at the general level, they were all discussed.

While there were very few surprises here, the close reflection of the uses and value of drawing as portrayed in the literature was very satisfying. The one surprise, Kyle's use of drawing as an initiator or impetus for action fits well with the others uncovered, and may in fact help explain the power of drawing as a catalyst for shared vision. Combined with the power of a drawing to focus the attention of multiple people, this factor may be an additional reason design drawing works.

Case Three: Nathan & Larry

Nathan is a soft-spoken instructional design intern at CID, working under the mentorship of Mark, a senior instructional designer. He had experience at simulations and other projects but had not done a simulation based on case studies before, like the Media Ethics project. Larry, the client/SME for the Media Ethics project, was a professor in the communications department. The Media Ethics project was to create a simulation where

students would test their skills at making ethical decisions in four communications subjects (broadcast journalism, print journalism, public relations, and advertising).

Nathan had had some informal meetings, and one design meeting with Larry that was not observed for the present study because it took place before this study started. Of that first meeting, Nathan said that they began by “floating ideas about what the final product would be like.” He said they wanted something concrete to work on, and so began by drawing a diagram on the board. What they came up with had many aspects of a flowchart, but some other parts or characteristics as well. Because the product they were designing was a simulation to give students opportunities for making ethical choices, Nathan felt that the meeting demonstrated the need to conduct some research about student interaction. He believed that the diagram on the board provided clarity for their discussion and a way to remember what had been discussed. Figure 4.10, a photograph of the white board at the end of their discussion, was obtained from Nathan.

In analyzing the white board in Figure 4.10, we see what looks like the beginning of a flowchart on the left side with the word “Intro” in a box with an arrow pointing to the words “Case description?”. It appears that this initial flowchart was abandoned, and the aims of the simulation were discussed because the three bubbles below contain the words “Disclosure” “Ethical Persuasion” and “Honesty.” Another flowchart toward the middle of the picture has a line drawn from one of four boxes with initials in them. The four boxes are initialed with “PR” (for “Public Relations”), “J” (for print “Journalism”), “BJ” (for “Broadcast Journalism”), and “ADV.” (for “Advertising”) and represent the four areas of communications from which the cases for simulation will be drawn. The implication is that

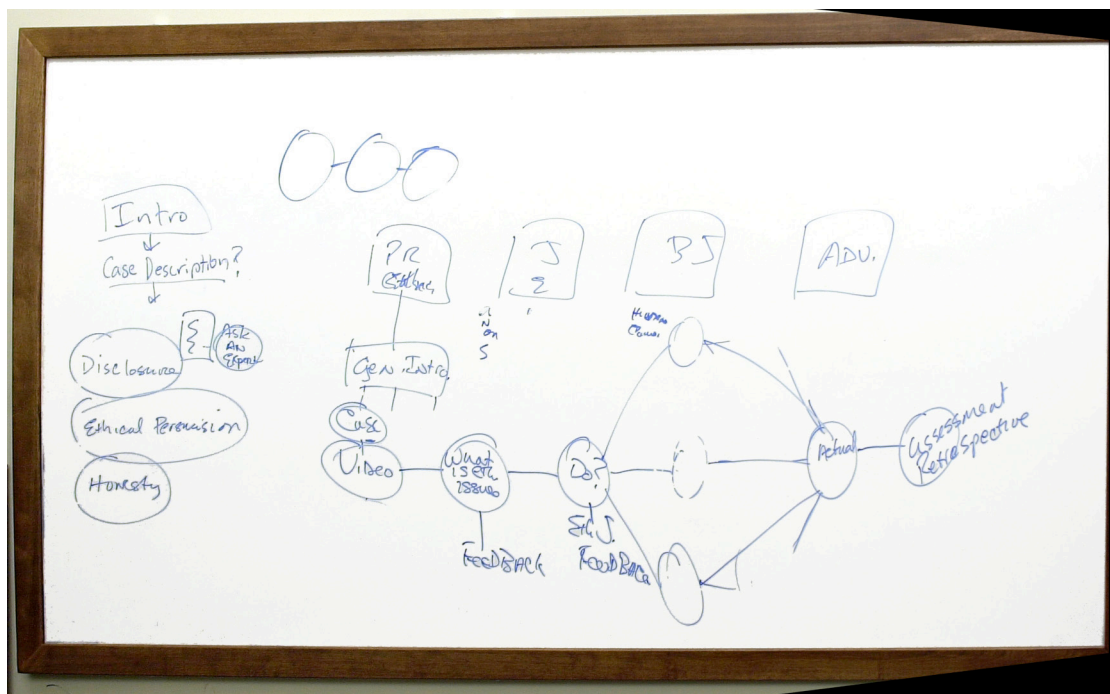

Figure 4.10. The white board at the conclusion of the first Media Ethics meeting. Note especially the diagram at the bottom, starting with “Video” on the left, and moving to “Assessment Retrospective” on the right.

any one of these subject areas may be the source of the simulation that follows. In the diagram, a line from the “PR” box to the next bubble is an example of the case belonging to that field. The bubble diagram immediately below the squares represents the simulation itself. It starts with a “Gen[eral] Intro[duction]” after which the “Case” is introduced with “Video.” After presenting the case, the instructional system would present the ethical issues (“What is eth[ic]al issues?” [sic]). All of this is the set up for the student to make a decision (“Do?”). (Also note the word “Feedback” below the “What...” bubble, and one of the words under the next bubble may also be the word “Feedback.”)

The split into three bubbles represents the decision the student makes, with the three parallel bubbles each representing a path, with consequences. The case, while fictional is based on an actual situation. When the simulation has played out, the student is then shown

an “Actual” result. Finally, the student’s last activity is something called an “Assessment Retrospective.”

This diagram appears to have parts that correspond to the content layer (for example, the four boxes with initials for content areas), the control layer (such as the ability to select a simulation track), and the message layer (what the student is presented), but it is mostly concerned with the strategy layer (how the simulation events unfold—how the instruction proceeds). What is reported here about this first design meeting is second hand (a picture of the white board taken at the conclusion of the meeting and a verbal report from one of the participants) but even with this limited evidence, it is pretty clear that the drawing played an important part of the development of the design of this simulation. There is evidence of design thinking, and the lack of a narrative limits what can be said about it.

On the other hand, I was privileged to observe the second design meeting in person. The second meeting seemed to start without a clear direction and meandered a little. Nathan picked up the discussion from the previous meeting by referring to a philosophy that he felt could be the basis for the student interaction. Larry responded by noting a similar method. As they talked, Nathan wrote an outline on the board (not shown) and then, on the left side of the white board, began to compose a kind of “to do” list of tasks for this project. The first task was to assist with a Web site with information for each of the content areas from which students may enter. As he discussed this task, he re-drew the boxes with initials representing the areas in communications that would contribute cases (Broadcast Journalism, etc.), and wrote what would be included in the Web site; see Figure 4.11.

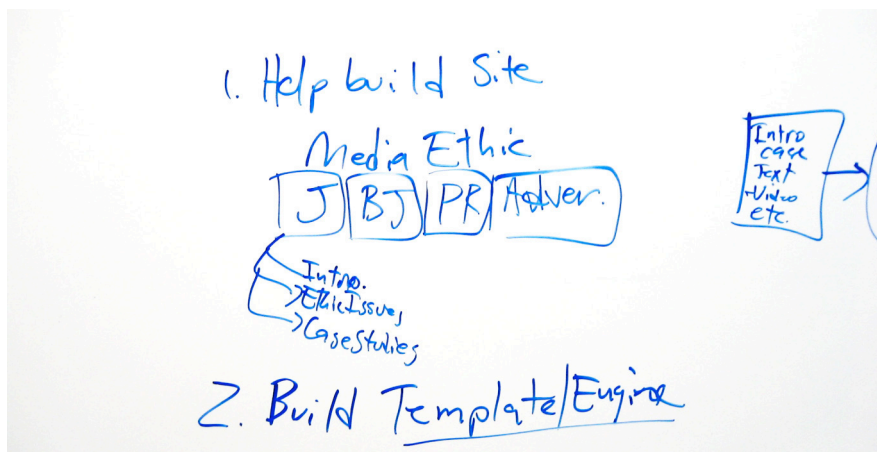

Figure 4.11. The left side of the white board during the second Media Ethics meeting.

This discussion led to the development of the simulation itself, and the need for them to provide a “Template/Engine” to allow the faculty to add their own cases. Both participants at that point seemed to need a review of the design, so Nathan began at the left with “Intro Case, Text, Video, etc.” As Nathan reviewed it, he began to redraw the branching flowchart shown in Figure 4.12.

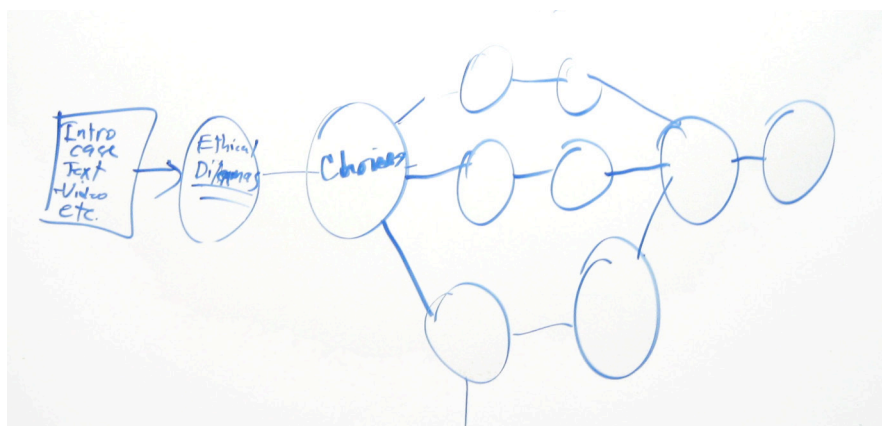

Figure 4.12. Lower right side of the white board. Compare with the bottom of Figure 4.10.

As he drew the bubble for “Ethical Dilemmas” he mentioned his recollection that students receive some “feedback” at this point in time (see Figure 4.10 from the first

meeting). For Larry, the client/SME, this did not seem to be the correct location for feedback. He explains,

“The feedback about ethical dilemmas? I’m not sure about that one. I didn’t think we were going to do feedback/expert response until after they had made a decision about it. My interpretation of it was that they would say ‘What is the ethical dilemma here or is there one?’ and then you would have them answer those questions. And then, they would choose what the right thing to do would be. And we’ve given them three options.

Nathan: “So they wouldn’t get feedback at this point on it?”

Larry: “No feedback at this point. The reason being is, the feedback, er, where I’m looking at the feedback...well, go ahead. So the feedback would be...hold on...” [Nathan later clarified in a follow up interview that they do, in fact, receive feedback at this point, but Larry was referring to the larger, full-case feedback]

Larry’s comment shows the need to clarify, and at this point Larry jumps to his feet, takes the white board marker, which Nathan has offered to him, and finishes out the diagram, showing the branching, the return from branching, and the rest of the bubbles from “Choices” to the right.

“...First they would identify and write down what the ethical dilemma is. (Now I don’t know if this would be a separate circle here, that would come to this point that would be the ‘Choices’) which would become one, two, three, options. Now, after they make the choice, they get to this [gesturing to the second bubble on each path] then I think there would be that expert feedback, ‘Here’s what happened as a result of your choice.’ The expert feedback would be here [pointing to the bubble where the three branches join back together]. (I don’t know if I’m doing this right, I’m not a designer)...And that would bring them all back to this choice, which is the expert saying, ‘Now, this is what we did do.’

At a couple of points during this exchange, Larry expresses his doubt about whether he is drawing the diagram correctly, perhaps not realizing that there is no “right” way. He also is using the design drawing with both narrative and gestures (pointing to the bubbles

he's talking about) to make his point. These behaviors clearly show the importance of narrative to design drawings, as would be predicted by the literature. It also illustrates an addition to the value of gestures in connection with design drawings, where the gesture is part of the discussion. As Gibbons would have predicted, the diagram with bubbles leading from the left, branching out, then coming back together has taken on the meaning of the main sequencing strategy of this simulation, and Larry has used this new design language "term" to aid in clarification of a part of the design. This is emphasized by the fact that the later bubbles (those to the right of the diagram) did not even need to be labeled to be useful for the discussion.

At this point in the discussion, Nathan suggests that they look at how their newly clarified design would work with a specific case that Larry has come prepared to discuss: the "Visa International" case. Nathan points to the "Intro" bubble, and invites Larry to read the introduction of this case, which Nathan does.

Piece by piece they go through the simulation using the case which Larry has brought to the meeting. At some points there is discussion about how the software will present information ("This could be text or video"). In other places, where the original case does not provide information (such as the three options to be offered to students) they brainstorm ideas for options. The case has been well written so that it did not reveal what the "real" solution was until the end, matching perfectly the need to keep information from students that might bias their decision-making.

This dry run-through, conducted as if it were being performed by the instructional software, serves the main purpose of design models as noted by Baynes (1992) and Goel

(1995) in the literature review, that is as a microcosm of the real thing to insure desired functionality without critical errors. As they run through this scenario, each felt comfortable interrupting the flow of the meeting to make comments about aspects of the design, such as media selection, content, etc. I could see the design drawing facilitated Goldschmidt's dialectic with *seeing as* and *seeing that* modes of thinking taking turns, not while drawing the diagram as expected, but while *using* the diagram as the guide to the simulation with gestures and references. The introduction of actual content turned this design meeting into a prototyping of the product. Due to prototyping with real content, this design seemed to go further, faster than any other project observed. Based on the discussion from these two design meetings and others, Figure 4.13 was composed to formalize this design.

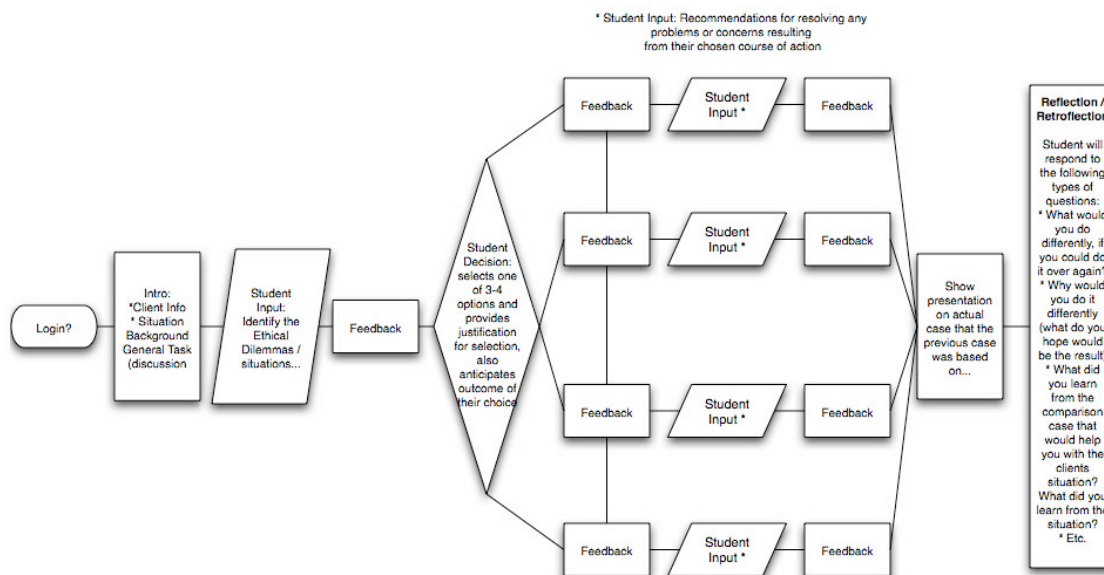

Figure 4.13. A formalized diagram of the strategy for the Media Ethics case study simulation.

Without access to the first meeting, it is hard to determine the value the sketch played in creating the design, but from Nathan's brief description and from the drawing

itself (Figure 4.10) it seems that Lockard's (2) inter-professional and (3) client communication were taking place. In the adaptation of Lockard's stages, (1) ideation and (2) negotiation were evident as well. Both Nathan's and Larry's uses of the key element as a term in their mutual design language demonstrates that it accomplished the purpose of shared vision as well, at the same time demonstrating Gibbons (2003) description of a design language whose terms evolve out of interactions during design.

In the second meeting there was abundant evidence of (2) negotiation, and even (3) persuasion. The meeting showed the value of vagueness in the drawing in that it allowed a rough design to be conceived and discussed without every detail evident. For example, the diagram became a focal point of discussion about feedback, allowing Larry, the client to identify specifically where he wanted the feedback to take place. One thing that makes this project especially interesting is that the client provided real data to use in "prototyping" the instructional design. Even though the "dry run" was of the lowest fidelity (verbal), when performed on the model on the white board, provided the designer and client with a lot of clarity in design choices at a very early stage of development. Finally, Figure 4.13 clearly exhibits the move toward more formalization, less creative expression as a design progresses, mentioned in several places in the literature.

Conclusion

In this chapter, we have seen three cases of the use of drawings in the design process. For the most part these cases demonstrate that design drawing in instructional design belongs to the same class of phenomenon as found in other fields of design, with some differences. These differences will be discussed further in the next chapter.

CHAPTER 5—DISCUSSION & CONCLUSIONS

The purpose of this chapter is to summarize findings of this study of design drawing in instructional design (ID). I will discuss my findings, draw conclusions regarding the use and value of design drawing in ID and make recommendations regarding further studies and training.

This study compared the value and use of design drawing in ID to design drawing in other design fields. The question that this study endeavored to answer was, “How is design drawing used in ID, and how does this compare with other design fields?” Because the question involves a comparison, design drawing in other design fields was explored through the literature of a field called *design studies*. The literature review also included a search for evidence of design drawing in the literature of ID. The literature of design drawing and sketching in design studies was rich and varied; the literature of ID showed comparatively little interest in design drawing.

For this dissertation, actual use of design drawing in ID was studied by observing ID processes at BYU’s Center for Instructional Design (CID) using a naturalistic and interview methods. Observations were made during design meetings, supplemented by interviews with instructional designers regarding their use of design drawing in the design process. Audio recordings of these meetings and interviews, along with photographs of design drawings and field notes were made and analyzed. From these observations and analyses, three case studies were assembled as representative of the use of design drawing at CID. These observations were analyzed in light of the two-part literature review described above, to try to get a clearer understanding of the use of design drawing in ID.

Design Drawing in ID and in Other Design Fields

What follows are sample observations organized into the themes found in the literature review. In addition, a few findings were not evident in the literature review, and these are discussed last.

Themes from the Literature Review

The literature review uncovered several important themes related to design drawing from both the general field of design studies and in ID. Among those, the following themes will be discussed:

1. The need for representation in design
2. The relationship between design drawing and design thinking
3. Design drawing as a design language
4. Design drawings reflect stages in the design process
5. Design drawings can be categorized by form
6. The value of vagueness that design drawing lends to the design process
7. Design drawing facilitates design as ill-defined problem solving
8. The dialectic of sketching
9. The close association of design drawing and the design narrative
10. Design drawing facilitates shared vision
11. Design drawing in ID tends to center on task/skill analysis
12. Design drawings in ID tend to reflect the strategy layer

What follows are examples of observations that relate to the literature survey for the purpose of comparison.

1. *The need for representation in design.* The literature review made note of the importance of representations to design. The importance of representations was also found to be true in the observations of design drawing in ID. I observed only one design meeting in which a design drawing was not used, and even in that meeting, as I recorded in my field notes, “[the client] is gesturing positionally,” and “lots of gestures” to indicate that representations were being “drawn in the air” as instructional sequence was discussed. At the end of that meeting, the suggestion was made that the situation warranted creation of a storyboard to guide production. Clearly, the use of some kind of representations (in this case, gestured ones) was important to the design effort. The use and importance of representation to design is a vital connection between ID and other fields of design.

2. *The relationship between design drawing and design thinking.* In the literature review, the case was made that design drawing is closely tied to design thinking. Design drawing in ID was observed to have the same close relationship. For example, in one observation, Kyle expressed the value he placed on design drawing. When asked if he ever draws when designing he replied, “Quite a bit. Typically the reason I [draw] is...when we just talk we’re not really making plans, we’re not really advancing anything. It’s kind of circular. But as soon as I start to get something down, then it feels like I’m moving forward...even [if the drawings are just] doodles in my head—I’m getting out of the circular pattern of thinking.” Another instructional designer added, “[Design drawing] helps us get closer to the idea.” Drawings help reify ideas.

3. *Design drawing as a design language.* The literature review made note of the fact that design drawing is a form of design language. In several observations of design drawing in

ID it became apparent that one role design drawing played was as a common language between designers and others—especially content providers. In Steven’s second meeting with Tammy in the first case in Chapter 4, the term “School Board,” referring to the situation they were going to use to frame their activity, took on a meaning that captured much of the way that activity would be conducted. The term “School Board” became a part of the design language between Steven and Tammy with a different meaning than the literal words. In another example, in the third case in Chapter 4, when Larry takes the white board maker from Nathan and finishes drawing the main flow (Figure 4.12), he is demonstrating that that web-like flow diagram had become a common expression in their shared design language. The diagram came to include a much larger meaning to Nathan and Larry than merely the flow that it diagrammed.

4. Design drawings reflect stages in the design process. In the literature review of general design studies, it was noted that design takes place in stages, and that these stages are reflected in the design drawings. Design drawings tend to move through a progression from simple to complex, from partial to complete, from vague to concrete. This progression was certainly observed during observations of ID. This movement was most clear in the third case in Chapter 4 with Nathan and Larry. In the diagram of the main flow of the simulation from the first meeting (Figure 4.10), this flowchart was drawn with a single bubble in each of three branches in the diagram. In the design drawing from the second meeting (Figure 4.12), Larry drew two bubbles in each of the three branches. Finally, the formal printed diagram (Figure 4.13) shows three bubbles after in each of four branches. In this third, formal design drawing, there is other evidence of this progression: the vague, oval “bubbles” of earlier

versions have become specific shapes (squares, parallelograms, etc.) with specific meanings and identified by specific labels. In a separate interview with another instructional designer, she said, “I don’t usually keep [early drawings] because they are very, very messy. Mainly it’s ‘just grab a piece of scratch paper and start drawing squares and triangles and circles and words and stuff.’ And then once I have something worth keeping I’ll take it into PowerPoint...”

5. *Design drawings can be categorized by form.* In the literature review it was demonstrated that design drawings can be classified by their form. Using Laseau’s work (1986) as a guide, four abstract forms were identified: bubble diagrams, area diagrams, matrices, and network diagrams. To these abstract diagrams, I added a fifth: representational diagrams. All five of these forms seem well represented in design drawing from other fields. On the other hand, the design drawings from the ID literature were quite limited. Our observations reflected this lack of variety as well.

For example, only one area diagram and one network diagram were observed out of over 50 examples of design drawings collected. (Note: design drawings included in this dissertation were those directly related to the three cases studied.) In addition, the only matrices observed were Steven’s outlines, noted in the first case of Chapter 4 (see Figures 4.1 and 4.3). Most abstract diagrams fell into Laseau’s bubble diagrams (see, for example, Figures 4.5 and 4.10), and nearly all of those were some kind of flowchart. Next most common were representational diagrams (see Figure 5.1 for an example). While all five forms were observed, there was a clear bias first for bubble diagrams, and second for representations.

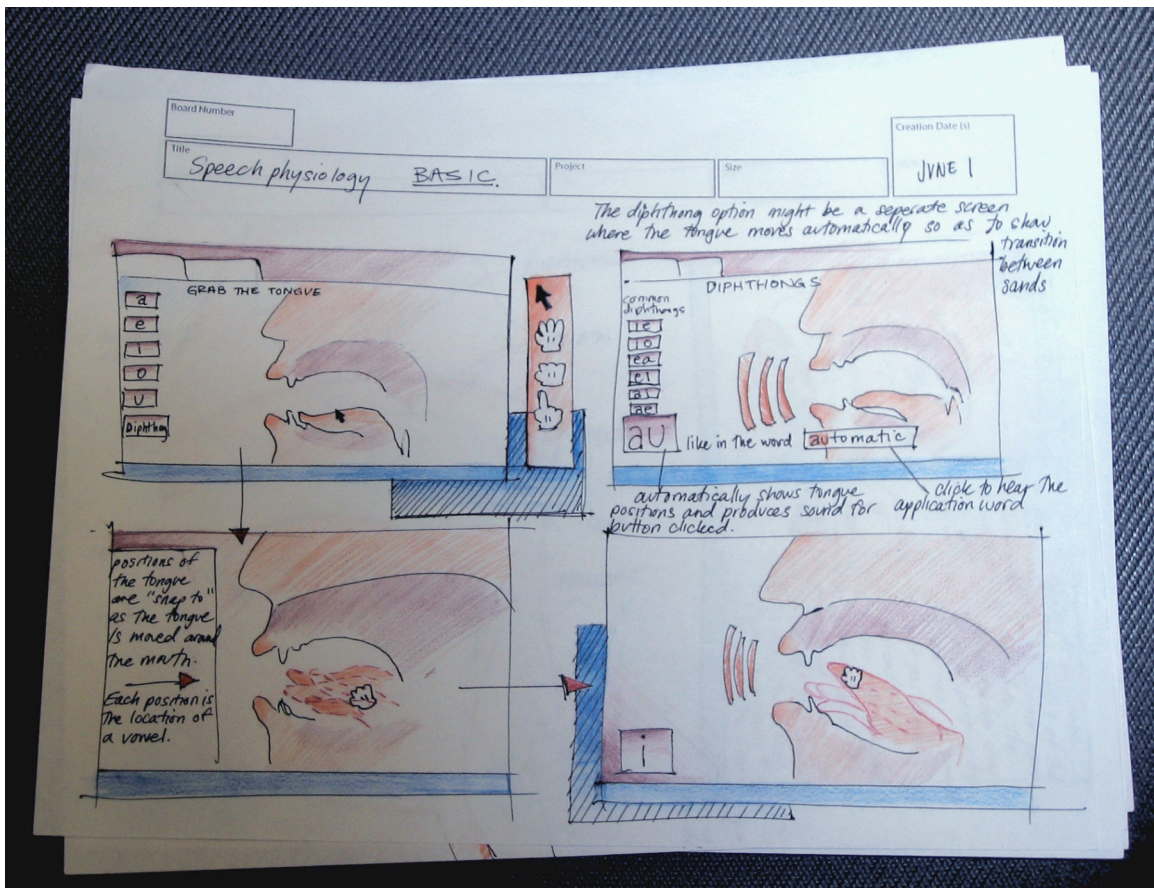

Figure 5.1. A set of storyboards from another of Steven's projects, Speech Science.

6. *The value of vagueness that design drawing lends to the design process.* It was shown in the literature review of other design fields, that the vagueness and ambiguity of design drawings and sketches is valued by designers. This is likely because the vagueness of design drawing supports design as the solving of ill-defined problems, and the dialectic of sketching (see below). This was also observed to be true in the design drawings of ID. In the second case in Chapter 4 about Kyle and Natalie, a flowchart of their rough design, as well as the "diamond" metaphor that described their instructional strategy, had been drawn on the white board (see the right side of Figure 4.5). Kyle and Natalie decided to take the ideas represented by their rough design drawing and flesh them out separately as storyboards. The

expectation seemed clear because storyboards are a common method of documenting Web sites, and each of them had done something like them before.

It was surprising that when they met for the second meeting, each had used their storyboards to address different, complementary aspects (layers) of the design. The vagueness of the representations from the first meeting enabled each of them to conceive and deliver these complementary storyboards. Merging the two sets of storyboards was made much simpler because of the storyboards represented different design purposes. The original drawing had permitted this ambiguity to occur—serving the needs of design well.

7. *Design drawing facilitates design as ill-defined problem solving.* In most other fields of design, design problems are often viewed as ill-defined problems. You will recall from the literature review that ill-defined problems are characterized by the problem being as much subject to change as the solution. The instructional design problems I observed were also often viewed as ill-defined, just as they are in other design fields.

An example of this phenomenon can be found in a comment from Earl, one of Steven's clients/SMEs. During one design meeting with Earl, it was pointed out that the proposed learning activities to be used outside of class would necessitate altering the way he would have to present his lectures in class. Earl said, "I want these learning activities to mesh with what I'm doing in class. So, if I have to change what I'm doing in class, great! I'm re-doing [my lectures] anyway. Believe me, this is *way* better than it was last semester, already!" That willingness to re-address the problem to fit the solution is indicative that what is going on in this situation fits nicely with other design fields' conception of design activities and thinking as ill-designed problems.

8. *The dialectic of sketching.* A very important paper cited in the literature review discussed the value to design of the dialect of sketching. In it, Goldschmidt (1991) observed a consistent movement, back and forth, between *seeing as* (imaginative) and *seeing that* (judgmental) design thinking. Despite not following her rigorous methodology, I did observe several instances of this same kind of back-and-forth between these two different ways of design thinking, and noted how the design drawing seemed to play an important role in facilitating them. One of the clearest examples of this took place during the second meeting between Kyle and Natalie mentioned in case two of Chapter 4. As Kyle and Natalie worked to merge their storyboards, a dialectic discussion ensued that permitted each of them to alternatively recommend solutions on how the merger would take place (*seeing as*) and then making judgments about how things should work (*seeing that*).

9. *The close association of design drawing and the design narrative.* The literature makes the case that design drawing is part of a narrative, without which, clear and complete understanding of the evolving design is difficult. In the third case, Nathan and Larry created a design using a design diagram on the white board in their first meeting, which I did not attend. The evidence about this first meeting collected by me included a photograph of the white board taken by Nathan, and four or five brief lines of field notes where Nathan described that first meeting to me. In spite of my not attending, I was able to reproduce the general meaning of the white board diagram, in large part because of things I learned at the second meeting, in which I did take part. However, when Nathan later reviewed my description of the first meeting, he noted that I was wrong about several subtle details, which he corrected for me. My reconstruction of the meaning was limited by my not having access

to the narrative that had created it. On the other hand, to Nathan and Larry, it was so clear that even a shorthand version—one without labels on most of the bubbles (Figure 4.12)—was sufficient to communicate important details between them.

10. Design drawing facilitates shared vision. Probably the culmination of these characteristics of design drawing from the literature review is that they facilitate shared vision, which, according to Bucciarelli (1994) is the very definition of design. For example, Nathan and Larry's common understanding of the vague flow diagram is also evidence that they each had mental pictures or visions of the final product that overlapped in significant ways, which permitted the design to move forward just as predicted in the literature. As a further example, it is clear that one of the main purposes of Steven's outlines from the first case study (see Figures 4.1 and 4.3) was to create shared vision among a group that had not been a part of earlier conversations. This seems to be one of design drawing's most important characteristics.

11. Design drawing in ID tends to center on task/skill analysis. If there is a tradition for design drawing in ID, it is in the area of task or content analysis, which takes place very early in the ID process. In the literature review, two of the textbooks studied used some form of hierarchical flowchart to document this purpose. However, in practice, I did not observe much content analysis being performed in this way—at least not to brainstorm, conceptualize, or negotiate content. The closest example of design drawing for content was found in Steven's outlines, which did represent content with a good deal of hierarchy and other placement-based meaning. Unfortunately, those outlines were quickly drawn and then

quickly ignored during the rest of the design meetings, which is probably evidence that they belonged to a much later stage of design than content analysis.

12. *Design drawings in ID tend to reflect the strategy layer.* In the literature review, Gibbons' design layers (Gibbons & Rogers, 2006) were used as a way to analyze design drawings by their value and purpose to the design. These layers are,

- content
- strategy
- control
- message
- representation
- media-logic
- data management

When applying this approach to the design drawings observed in this study, the majority of them illustrated the strategy layer. Many of them secondarily illustrated other layers as well, but the strategy layer was the most prevalent. This was in spite of the fact that a large number of drawings represented screen designs—illustrating either the representation or message layers.

Emphasis on the strategy layer may result from the fact that a majority of projects at CID are for computer- and Web-based instructional materials. In those media types, bubble diagrams that show logic flow are the most commonly used form of diagram. This has conveniently transferred to ID from these other design fields because of the importance of sequence of learning events to ID. This is particularly true for Web design where the learning sequence, the organization of the content, and structure of the Web pages are often represented in the same diagram.

Observations unanticipated from the literature review

Other characteristics of design drawing in ID were unanticipated from the literature.

I will address three of these:

1. The use of design drawings as impetus to action
2. Gestures as a substitute for design drawing
3. The instrumental value of design drawings in addition to the value in their

construction.

1. The use of design drawing as impetus to action. The literature review noted that design drawings are used for both exploration and development by designers. However, an additional purpose was also noted: to impel designers to action or to maintain momentum. Kyle stated in his interview that he often uses design drawing as way to get started on a design, to get out of, “circular” or non-productive reasoning. Using design drawing as in this way represents the emotional aspect of exploratory and developmental design activities. The need to produce something or to show progress is a very strong emotional reward that at least some designers use to get them started on a design.

As an example, Steven used his outlines to bring others “up to speed” on previously discussed designs. I believe the purpose of this was to create forward momentum, as well as to provide information. The production of Steven’s outlines took place very early in the meetings (within the first 12 minutes or so). While the outlines seemed important, they were not referred to again during the meetings. This could be because the value of the outline was to as much to move participants to action as to inform them, and to help draw the team members together.

2. *Gestures as a substitute for design drawing.* Another theme not anticipated from the literature review was the use of gesture as a substitute, and sometimes an enhancement, for design drawing. Steven's three-fingered gesture mentioned in the first case study is only one example of how gestures may be used as very ephemeral drawings. Just as in real drawings, in gestured drawings, position has meaning, and the narrative is a necessary addition to the meaning of the gestures that serves as a label. The downside of using gestures is their transient nature—being even more temporary than that of white board drawings, which were often photographed for later reference. The advantage to gestured drawings is that they can help clarify concepts on the fly, using an easy-to-use, natural, spatial language. There were even instances where a gestured drawing was used to propose something during the negotiation stage, which was then written down on the white board after participants had reached agreement. Gestured drawing is part of a larger repertoire that designers and others use to design and communicate their designs.

3. *The instrumental value of design drawing.* The literature of design studies focuses on the production of design drawings much more than their use. In many instances, once a drawing was on the board, even partially, it became instrumental to the discussion by being referred to and talked about. Gesturing was often part of this instrumental use of design drawings. This gesturing was not limited to mere pointing; sometimes, for example, boxes on the board might be referenced in the speaker's hands as if holding them. The speaker might then push them together to indicate merging them, or selectively grasp and "move" them to a new location.

For example, when Larry finished his drawing of the branching exercise in the second meeting of case three, his purpose was to identify the location of feedback. Notice that Figure 4.12 has no label toward the right-hand side where the feedback would be located. The figure was drawn so it could be used for discussion, not for its own sake. This kind of behavior was observed in nearly every design-drawing situation.

Summary of Findings

Design drawing, so common in other fields of design, is also present in ID and plays an important and prominent role in the development of instructional designs. In addition, design drawing in ID fulfills many of the same roles and provides to the design most of the same advantages as it does in other design fields. Design drawing in ID is clearly the equivalent activity to the design drawing seen in other fields of design.

However, design drawing as observed in ID demonstrated some definite differences as well. Observed design drawing in ID used a very limited repertoire of forms, as noted above. Also, design drawing in ID was used to represent the strategy layer of design more than for any other purpose. In contrast, the literature of design studies demonstrated a much higher level of self-awareness in the use of drawings during design than was found in ID. While design drawing seems to be as important to ID as it is to other fields, there is something missing, or we should have found more variety of forms covering a broader number of purposes. ID seems to lack a self-awareness of design drawing that would be essential for its study. Also, there are few standards for representing ID.

Limitations

Limitations of this study stem primarily from the selection of a single case study subject: BYU's Center for Instructional Design (CID); and, the short timeframe in which the study was conducted. Further limitations are a result of circumstances surrounding data collection.

Because this study was conducted at a single institution, results may be biased by the organization and traditions at that institution. For example, instructional design teams were all composed of people occupying the identical roles in each team. Observed outcomes may have been different in a less homogeneous environment, or if multiple environments had been observed. However, following Stake's (1995) suggestion, we conduct qualitative studies based on what we can learn from this one case. In this case, though I conducted observations at a single institution, the use of design drawing varied from team to team, and from individual to individual so that I am content that I witnessed a broad range of behaviors. This study's transferability might have been stronger if it had been conducted in multiple institutions.

The timeframe for this project—a one month period of time—was specifically chosen to capture a “snapshot” of designing at CID rather than an in depth view of any one design effort. In this case, it was successful at providing a brief, summary view. The timeframe selected was to coincide with the beginning of several projects, so that early design efforts could be observed. All three of the cases outlined in this study are of early instructional design efforts. However, the short length, and the specific timing to coincide with projects in early phases probably biased the drawings observed. For example, it was

observed that Gibbons' content and strategy layers were most represented in these design drawings. That may be a result of timing: content and strategy might be the very issues that are designed first. But, it also begs the question that instructional design may often be limited to those layers, with programmers and artists called in to handle the design of other layers. This question needs further study (see below).

It was also noted that I was not able to capture any of the personal drawings mentioned particularly in the literature review. As mentioned, very often these are discarded as mere vehicles to obtain the later, more perfected drawings. One interviewee said as much, that she quickly discarded her early design drawings as soon as they were superseded by better-drawn (and presumably, less vague) drawings. This could be considered a limitation of the method used, where only those drawings were captured during meetings or interviews. For example, another approach that might of obtained some of these drawings would be to give digital cameras to participants and ask them to capture their own personal drawings as they occurred. However, this method, too, has its limitations as it removes many of the benefits of a naturalistic study from the observations because the resulting drawings may be influenced by the necessity of taking photographs of them.

Recommendations for Future Research

This dissertation has shown that, at least in the area of design drawing, instructional design is very much like other design fields. In spite of this, ID does not seem to be taking advantage of design drawing as these other fields do. This important set of facts opens several opportunities for future study.

Why is there a difference between design drawing in ID and other fields? The first question is, if design drawing is so valued in other design fields, why is it not more prevalent in the field of instructional design? Several possibilities exist: ID does not have the tradition for design drawing, there is a lack of training among instructional designers, or there are few standards for design drawing in instructional design. A fourth possibility is that, because ID works through other media to accomplish its goals, the design techniques of those other fields, including design drawing, are the only ones used. We will look at each of these possibilities separately.

Most other fields of design (architecture, graphic design, industrial design, engineering, etc.) grew out of crafts for which drawing was considered an important skill. For example, architecture grew out of the building trades, for which the value of drawing has long been understood as an essential skill. Its value in cost- and time-savings is well known, but its relationship to creativity in design is also understood.

The modern study of instructional design, on the other hand, traces its heritage to the public school teacher, and later, the psychologist (see May, 2006). In neither of these “trades” is drawing an important aspect of planning. (Another ancestor of modern ID is systems thinking, a field for which the bubble diagram is common—possibly explaining its popularity in ID.) Instructional design simply does not have design drawing as an important part of its tradition (except, as noted above, in content/task analyses and strategic flow diagrams).

A quick survey of the courses for instructional technology at three universities revealed no course in design drawing. That is not to say drawing is not taking place, but it

does not appear to be a skill to be instructed. In my own experience at two of those universities, it was not a formal subject of any of my coursework. Speaking with instructional designers who have experience in production would seem to indicate anecdotally that its use in the actual practice of ID is common, but its training is not. Observations from this study would seem to support its widespread use, and the lack of tradition or training may be supported by the fact that it is used so narrowly.

Finally, there are few standards for the use of design drawing in instructional design. Except for task or content analyses using in early design, attempts to provide Visual Instructional Design Language (VIDL) are only beginning to appear, of which Paquette's (Paquette, 1996; Paquette, Aubin, & Crevier, 1994; Paquette, de la Teja, Lundgren-Cayrol, Léonard, & Ruelland, 2002; Paquette, Léonard, Lundgren-Cayrol, Mihaila, & Gareau, 2006) and Botturi's (2003) methods are examples. The regular use in practice of either of these standards or any other might provide the basis for new standards on which to build instructional design drawings. However, while design drawing is common in ID, currently no standards are common or well known among ID practitioners.

A fourth possible explanation of the scarcity and narrowness of design drawing in ID may stem from the fact that ID, unlike in other fields of design, does not have its own unique medium or outcome, so design methods vary with the medium. An industrial designer designs products, like toasters and automobiles: the medium of expression, while highly varied, is always a physical, mechanical thing with physical properties that are well known. A graphic designer designs printed or displayed material. A moviemaker designs stories through the action or movement on a screen, etc. An instructional designer designs

experiences, which may involve many of these things and more. Any given instructional design might include a mechanical object (industrial design), a visualization (graphic design), a film or video (movie making), or even a performance (theater director?), all of which are orchestrated (designed) to culminate in learning on the part of participants. Because of this, instructional designers often borrow the models and design methods from these various fields to convey their design ideas. Still, there is little in the way of tradition, training, or standards to design the orchestration of these things as a learning experience—that is, the instructional design part.

The reasons design drawing is not prevalent needs further study so that, by understanding its root causes, we would be better prepared to understand design drawing's potential to instructional design.

Why are design drawings in ID focused on strategy and content? As mentioned above, one observation of this study was that design drawings were limited to content and strategy layers. It has been suggested that this may have been a limitation of the timing of the study, but other possibilities exist. For example, the organized production teams at CID consist of artists and programmers as well as instructional designers. For each project, the teams usually include a client, who is a subject matter expert as well. Because of these roles, it is possible that the instructional designers focus on structuring the content and determining the instructional strategy as being the pieces of design that “belong” to them, while artists have more ownership of things that fall in the representation layer, programmers over objects in the media-logic and control layers, and SMEs over the message layer and other parts of the

content layer. If this is true, ID has been, in this instance, relegated to a less than complete role in the design of a learning experience.

Because of the importance of the questions that this possibility raises, this is an area of instructional design that deserves further study. Design drawing may serve as a medium to conduct that study.

Would ID practice be improved with improved design drawing? Probably one of the most important questions raised by this study, and one of the assumptions of this study, is whether the practice of ID would be improved by the inclusion of design drawing as a method, technique, tool, or design language. Its value to other design fields, combined with their apparent similarity to ID suggest that it would, but further study is needed to confirm this.

Related to design drawing's prevalence in other design fields is the fact that there may be a plethora of other design behaviors, practices, and methods of training, from which instructional designers might gain. For example, might instructional designer expertise be improved by studying instructional design in a studio environment similar to that in which architects and graphic designers learn? Schön's reflective dialogue is one of these techniques, appropriate for a studio approach. (For example, the instructional technology program at the University of Georgia has a series of courses they call "the Studio" in which students work independently on projects, learning specific tools as needed to complete their projects. Boling (2006) has also used a studio approach in instructional systems technology courses with promising effects. How have these approaches, so similar to the training of designers in other fields, affected the quality of their graduates?) The study of design drawing will not

answer these questions, but it might be a catalyst to understanding ways in which ID might benefit by observing the way other design fields “work.”

Schatz (2003) suggested, ID needs its own design language standard to provide a means of communicating the design to others as well as to coordinate the various media to their instructional ends. I would further argue that this instructional design language needs to provide for the conception, development, and negotiation of instructional designs as well as their communication. These aspects of design drawing would not only provide the ability to correct errors that Schatz suggests, but also to improve and enhance the creativity of the designs. Indeed, all of those positive characteristics attributed to design drawing by those studies of it in the literature might be a part of it: having the appropriate degree of vagueness to support design, facilitating the dialectic that stimulates the realization of the design, providing a catalyst for shared vision, and so forth.

What are the inner workings of design drawings in ID? If design drawing’s value to ID is confirmed, then studies that understand the workings of design drawing in ID will become very important. Some of these may derive from the kinds of studies mentioned in the literature review of this dissertation, but many would be specific to the use and value of design drawing to the practice of ID.

For example, if it is established that design drawing as a valuable tool for ID, how does it work to improve instructional design?

Where will standards for this new design tool come from? Architecture and engineering achieve an economy of communication through the diagrammatic symbols they employ. Where will the common symbols for ID come from? Will they be intentionally

developed from sources like Paquette and Botturi, or will they develop organically out of everyday use?

One of the values highlighted in the literature review the value of design drawing to the solving of design problems. What special challenges will arise from the design problems of instructional designers?

Design drawing has been portrayed as a design language. If it is a language, what are the rules or characteristics of its use? What are its primitive elements? What does its grammar look like?

It is clear from the literature that one of the principal values derived from design drawing is that it empowered judgment, what would be called formative evaluation in ID. How might design drawing improve the practice of formative evaluation?

In this chapter, we have attempted to make the connection between the literature review and the observations. Several points of intersection were observed, leading to the finding that design drawing inside ID and outside of ID in other design fields are related to one another. Unanticipated findings were also noted, such and the extensive use of gestures as a kind of design drawing.

Given these conclusions, several suggestions were made for additional inquiries regarding this valuable design language and instructional design.

REFERENCES

- Alexander, C. (1979). *The timeless way of building*. New York: Oxford University Press.
- Alexander, C., Ishikawa, S., & Silverstein, M. (1977). *A pattern language: towns, buildings, construction*. New York: Oxford University Press.
- Alhir, S. S. (2003). *Learning UML* (1st ed.). Sebastopol, CA: O'Reilly.
- Analysis & Technology, I. (1995). Competencies and skills for instructional designers [Electronic Version]. Retrieved May 2006 from <http://www.coedu.usf.edu/it/resources/competency.cfm>.
- Archer, B. (1992). As complex as ABC. In P. Roberts, B. Archer & K. Baynes (Eds.), *Modelling : the language of design*. Loughborough England: Loughborough University of Technology, Department of Design and Technology.
- Archer, B., & Roberts, P. (1992). Design and technological awareness in education. In P. Roberts, B. Archer & K. Baynes (Eds.), *Modelling: the language of design*. Loughborough, England: Loughborough University of Technology, Department of Design and Technology.
- Arnheim, R. (1995). Sketching and the psychology of design. In V. Margolin & R. Buchanan (Eds.), *The idea of design* (pp. xxii, 285 p.). Cambridge, MA: MIT Press.
- Baynes, K. (1992). The role of modelling in the industrial revolution. In P. Roberts, B. Archer & K. Baynes (Eds.), *Modelling : the language of design*. Loughborough, England: Loughborough University of Technology, Department of Design and Technology.
- Boling, E. (2006). *The summer studio: experiencing design culture and habits within an ID graduate program*. Paper presented at the annual conference of the Association for Educational Communication and Technology (AECT), Dallas, TX, October 2006.
- Boot, E. W. (2005). *Building-block solutions for developing instructional software*. Unpublished Dissertation, Open Universiteit, Nederland.
- Botturi, L. (2003). *E2ML: Educational Environment Modeling Language*. Unpublished Dissertation, University of Lugano, Lugano, Switzerland.

- Bradford, P., Wurman, R. S., & Graphis Press Corp. (1996). *Information architects*. Zurich, Switzerland: Graphis Press Corp.
- Brunner, J. (2003). The narrative construction of reality. In M. Mateas & P. Sengers (Eds.), *Narrative intelligence* (pp. vii, 340 p.). Amsterdam; Philadelphia, PA: J. Benjamins, Publisher.
- Bucciarelli, L. L. (1994). *Designing engineers*. Cambridge, MA: MIT Press.
- Budgen, D. (2003). *Software design* (2nd ed.). Harlow, England; New York: Pearson/Addison-Wesley.
- Caffarella, E. P. (2005, January 2005). Doctoral research in educational technology: a directory of dissertations, 1977–2004. Revised January 2005. Accessed October 2005 from <http://cortland.edu/education/dissdir/displai4.htm>
- Canemaker, J. (1996). *Before the animation begins: the art and lives of Disney inspirational sketch artists* (1st ed.). New York: Hyperion.
- Cooper, A., & Reimann, R. (2003). *About face 2.0: the essentials of interaction design*. New York: Wiley.
- Craig, D. L. (2001). Stalking Homo Faber: a comparison of research strategies for studying design behavior. In C. M. Eastman, W. M. McCracken & W. C. Newstetter (Eds.), *Design knowing and learning : cognition in design education* (1st ed., pp. x, 318 p.). Amsterdam ; New York: Elsevier.
- Cross, N. (2001). Design cognition: Results from protocol and other empirical studies of design activity. In C. M. Eastman, W. M. McCracken & W. C. Newstetter (Eds.), *Design knowing and learning: cognition in design education* (pp. 79-103). Amsterdam: Elsevier.
- Dervin, B., Foreman-Wernet, L., & Lauterbach, E. (2003). *Sense-making methodology reader: selected writings of Brenda Dervin*. Cresskill, NJ: Hampton Press.
- Dick, W., & Carey, L. (1990). *The systematic design of instruction* (3rd ed.). Glenview, IL: Scott, Foresman/Little, Brown Higher Education.
- Donahue, B. (1978). *The language of layout*. Englewood Cliffs, NJ: Prentice-Hall.

- Dorst, K., & Cross, N. (1996). Creativity in the design process: co-evolution of problem-solution. *Studies*, 17(4), 341-361.
- Eastman, C. M. (1969). Cognitive processes and ill-defined problems: a case study from design. *Proceedings of the First Joint International Conference on IA, Washington, DC*, 669-690.
- Eisner, E. W. (1998). *The enlightened eye: qualitative inquiry and the enhancement of educational practice* (2nd ed.). Upper Saddle River, NJ: Merrill.
- Ely, D. P., & Plomp, T. (1996). *Classic writings on instructional technology*. Englewood, CO: Libraries Unlimited.
- Ertmer, P. A., & Quinn, J. (2003). *The ID casebook: case studies in instructional design* (2nd ed.). Upper Saddle River, NJ: Merrill.
- Figl, K., & Derntl, M. (2006). *A comparison of visual instructional design languages for blended learning*. Paper presented at the World Conference on Educational Multimedia, Hypermedia, & Telecommunications, Orlando, FL, June 26–30, 2006.
- Gagné, R. M., Briggs, L. J., & Wager, W. W. (1992). *Principles of instructional design* (4th ed.). Fort Worth, TX: Harcourt Brace Jovanovich College Publishers.
- Gastfriend, H. H., Gowen, S. A., & Layne, B. H. (2001). *Transforming a lecture-based course to an internet-based course: a case study*. Paper presented at the National convention of the Association for Educational Communications and Technology, Atlanta GA, November 8–12, 2001.
- Gedenryd, H. (1998). *How designers work—making sense of authentic cognitive activities*. Unpublished Dissertation, Lund University, Lund, England.
- Gibbons, A. S. (2003). What and how do designers design? A theory of design structure. *TechTrends*, 47(5), 22–27.
- Gibbons, A. S., & Bunderson, C. V. (2004). Explore, explain, design. *Encyclopedia of Social Measurement*.
- Gibbons, A. S., & Rogers, P. C. (2006). Coming at design from a different angle: functional design. Unpublished paper, Brigham Young University.
- Goel, V. (1995). *Sketches of thought*. Cambridge, MA: MIT Press.

- Goetsch, D. L., Chalk, W. S., Nelson, J. A., & Rickman, R. L. (2005). *Technical drawing* (5th ed.). Clifton Park, NY: Thomson Delmar Learning.
- Goldschmidt, G. (1991). The dialectics of sketching. *Creativity Research Journal*, 4(2), 123-143.
- Griffin, M. M., & Robinson, D. H. (2005). Does spatial or visual information in maps facilitate text recall? Reconsidering conjoint retention hypothesis. *Educational Technology Research and Development*, 53(1), 23-36.
- Guba, E. G., & Lincoln, Y. S. (1989). *Fourth generation evaluation*. Newbury Park, CA: Sage Publications.
- Hall, H. M. (2004). *An examination of instructional design from theory to practice: a collective case study*. Unpublished Dissertation, University of New Mexico, Albuquerque NM.
- Hanks, K., & Belliston, L. (1977). *Draw : a visual approach to thinking, learning, and communicating*. Los Altos, CA: W. Kaufmann.
- Hansen, Y. (1999). Visualization for Thinking, Planning, and Problem Solving. *Information Design*, 193-220.
- Hart, J. (1999). *The art of the storyboard: storyboarding for film, TV, and animation*. Boston: Focal Press.
- Haynes, W. (1989). Preserving institutional memory: the contents of a property archive [Electronic Version]. Retrieved 29 April 2006 from <http://www.sacredplaces.org/PSP-InfoClearingHouse/articles/Preserving%20Institutional%20Memory.htm>
- Henderson, K. (1998). The role of material objects in the design process: a comparison of two design cultures and how they contend with automation. *Science, Technology, & Human Values*, 23(2), 139-174.
- Institute for Scientific Information. ISI web of science [Electronic Version]. Accessed April, 2006, from http://isiknowledge.com/wos_
- Jackendoff, R. (1996). *The architecture of the language faculty*. Cambridge, MA: MIT Press.
- Jacobson, R. E. (1999). *Information design*. Cambridge, MA: MIT Press.

- Jones, J. C. (1970). *Design methods : seeds of human futures*. London; New York: Wiley-Interscience.
- Jones, J. C. (1992). *Design methods* (2nd ed.). New York: Van Nostrand Reinhold.
- Kalyuga, S., & Sweller, J. (2005). Rapid dynamic assessment of expertise to improve the efficiency of adaptive e-learning. *Educational Technology Research and Development*, 53(3), 83–93.
- Kays, E. J. (2003). *Architecture and instructional design: A conceptual model for e-learning*. Unpublished Dissertation, Capella University, Minneapolis, MN.
- Kivett, H. A. (1998). Free-hand sketching: a lost art? *Art, Architecture and Design*, 12(1).
- Laseau, P. (1975). *Graphic problem solving for architects & builders*. Boston: Cahners Books.
- Laseau, P. (1986). *Graphic problem solving for architects and designers* (2nd ed.). New York: Van Nostrand Reinhold.
- Laseau, P. (1989). *Graphic thinking for architects and designers* (2nd ed.). New York: Van Nostrand Reinhold.
- Liu, M., & Bera, S. (2005). An analysis of cognitive tool use patterns in a hypermedia learning environment. *Educational Technology Research and Development*, 53(1), 5–21.
- Lockard, W. K. (1977). *Drawing as a means to architecture* (Rev. ed.). Tucson, AZ: Pepper Pub.
- Ludwig-Hardman, S. (2003). *Case study: instructional design strategies that contribute to the development of online learning community*. Unpublished Dissertation, University of Colorado at Denver, Denver CO.
- Massironi, M. (2002). *The psychology of graphic images: seeing, drawing, communicating*. Mahwah, NJ: L. Erlbaum.
- May, W. E. (2006). *An analysis of the usability of Model-Centered Instructional Design theory and implication for the design of training: a case study*. Unpublished Dissertation, University of Idaho, Moscow, ID.

- McCloud, S. (1993). *Understanding comics*. Northampton, MA: Kitchen Sink Press.
- McKim, R. H. (1980). *Thinking visually : a strategy manual for problem solving*. Belmont, Calif.: Lifetime Learning Publications.
- Moore, K. (2000). Between the Lines: the role of drawing in design. *Environments by Design*.
- Moustakas, C. E. (1990). *Heuristic research: design, methodology, and applications*. Newbury Park, CA: Sage Publications.
- Murphy, D. (1992). Is Instructional Design Truly a Design Activity? *Educational and Training Technology International*, 29(4), 279-282.
- Newell, A., & Simon, H. A. (1972). *Human problem solving*. Englewood Cliffs, NJ: Prentice-Hall.
- Newman, M. W., & Landay, J. A. (2000). Sitemaps, storyboards, and specifications: a sketch of Web site design practice. *Proceedings of the conference on Designing interactive systems: processes, practices, methods, and techniques*, 263-274.
- Object Management Group. (2006). Introduction to OMG's Unified Modeling Language™ (UML®). *Unified Modeling Language™* [Electronic Version]. Retrieved May 2006, from http://www.omg.org/gettingstarted/what_is_uml.htm
- Oxford American Dictionaries* [Electronic Version]. (2005). Accessed through Apple Computer dictionary application (Version 1.0.1).
- Paas, F., Tuovinen, J. E., van Merriënboer, J. J. G., & Darabi, A. A. (2005). A motivational perspective on the relation between mental effort and performance: optimizing learner involvement in instruction. *Educational Technology Research and Development*, 53(3), 25–34.
- Paquette, G. (1996). La modélisation par objets types [Electronic Version]. Accessed May 2006 from <http://www.liceftelug.liceftelug.ca/gp/docs/pub/modelisation/lamodeli.doc>, Laboratoire LICEF, Montréal, Canada.
- Paquette, G., Aubin, C., & Crevier, F. (1994). An intelligent support system for course design. *Educational Technology*, 31(9), 50-57.

- Paquette, G., de la Teja, I., Lundgren-Cayrol, K., Léonard, M., & Ruelland, D. (2002). La modélisation cognitive, un outil de conception des processus et des méthodes d'un campus virtuel. *Revue de l'éducation à distance*, 17(3).
- Paquette, G., Léonard, M., Lundgren-Cayrol, K., Mihaila, S., & Gareau, D. (2006). Learning Design based on Graphical Knowledge-Modelling. *Educational Technology & Society*, 9(1), 97-112.
- Patton, M. Q. (1990). *Qualitative evaluation and research methods* (2nd ed.). Newbury Park, CA: Sage Publications.
- Phyo, A. (2003). *Return on design: smarter Web design that works*. Indianapolis, IN: New Riders.
- Press, M., & Cooper, R. (2003). *The design experience : the role of design and designers in the twenty-first century*. Aldershot, Hants, England ; Burlington, VT: Ashgate.
- Reitman, W. R. (1965). *Cognition and thought; an information-processing approach*. New York: Wiley.
- Rittel, H., & Webber, M. M. V. (1973). Dilemmas in a general theory of planning. *Policy Sciences*, 4(2), 155-169.
- Robbins, E., & Cullinan, E. (1994). *Why architects draw*. Cambridge, MA: MIT Press.
- Rogers, C. R. (1983). *Freedom to learn for the 80's*. Columbus, OH: C.E. Merrill Pub. Co.
- Rowland, G. H. (1993). Designing and instructional design. *Educational Technology Research and Development*, 41(1), 79-91.
- Saba, F. (2005). Exclusive interview: Dr. Harold Nelson, Author of "The Design Way." [Electronic Version]. Retrieved April 2006 from <http://www.distance-educator.com/dnews/print.php?sid=13424>.
- Saddler, H. J. (2001). Understanding design representations. *Interactions*, 8(4), 17-24.
- Schatz, S. (2003). A matter of design: a proposal to encourage the evolution of design in instructional design. *Performance Improvement Quarterly*, 16(4).

- Schön, D. A. (1987). *Educating the reflective practitioner: toward a new design for teaching and learning in the professions* (1st ed.). San Francisco: Jossey-Bass.
- Schrage, M. (1999). *Serious play: how the world's best companies simulate to innovate*. Boston: Harvard Business School Press.
- Schwandt, T. A. (1998). Constructivist, interpretivist approaches to human inquiry: Pages. 221–259. *The landscape of qualitative research: theories and issues*. Thousand Oaks, CA: Sage Publications.
- Seo, K. K., & Gibbons, A. S. (2003). Design languages: a powerful medium for communicating designs. *Educational Technology*, 43(6).
- Simon, H. A. (1996). *The sciences of the artificial* (3rd ed.). Cambridge, MA: MIT Press.
- Simon, M. (2000). *Storyboards: motion in art* (2nd ed.). Boston, MA: Focal Press.
- Stake, R. E. (1995). *The art of case study research*. Thousand Oaks, CA: Sage Publications.
- Tang, H. H., & Gero, J. S. (2001). Sketches as affordances of meanings in the design process. *Visual and Spatial Reasoning in Design II, Key Centre of Design Computing and Cognition, University of Sydney, Sydney*, 271-282.
- Thomas, F., & Johnston, O. (1981). *Disney animation: the illusion of life*. New York, NY: Abbeville Press.
- Tversky, B. (2002). What do Sketches Say about Thinking? *2002 AAAI Spring Symposium, Sketch Understanding Workshop, Stanford University, AAAI Technical Report SS-02-08, March, 2002*, 148-151.
- Twitchell, D. (2001). *A rapid prototyping model for the design and development of instructional systems in practice: a case study*. Unpublished Dissertation, Utah State University, Logan UT.
- Ullman, D. G., Wood, S., & Craig, D. L. (1990). The importance of drawing in the mechanical design process. *Computers & Graphics*, 14(2), 263-274.
- University Microfilms. ProQuest digital dissertations [Electronic Version]. Accessed April 2006 from <http://wwwlib.umi.com/dissertations>

- Van Duyne, D. K., Landay, J. A., & Hong, J. I. (2003). *The design of sites: patterns, principles, and processes for crafting a customer-centered Web experience*. Boston: Addison-Wesley.
- Verstijnen, I. M., Hennessey, J. M., van Leeuwen, C., Hamel, R., & Goldschmidt, G. (1998). Sketching and Creative Discovery. *Design Studies*, 19(4).
- Vygotski, L. S., & Kozulin, A. (1986). *Thought and language* (Translation newly rev. and edited / ed.). Cambridge, MA: MIT Press.
- Waters, S. H., & Gibbons, A. S. (2004). Design languages, notation systems, and instructional technology: a case study. *Educational and Training Technology International*, 52(2), 57–68.
- Williams, D. D. (2002). *Qualitative Inquiry for Educators*. Unpublished manuscript, Brigham Young University, Provo, UT.
- Yin, R. K. (1994). *Case study research : design and methods* (2nd ed.). Thousand Oaks, CA: Sage.
- Zimring, C., & Craig, D. L. (2001). Defining design between domains: an argument for design research á la carte. In C. M. Eastman, W. M. McCracken & W. C. Newstetter (Eds.), *Design knowing and learning: cognition in design education* (pp. 79-103). Amsterdam: Elsevier.